

REFER

EHS
90

Where Do
We Go
From Here?!

Spirit reaches new heights



School spirit at EHS was shown in a variety of ways throughout the year. The regular pep assemblies and spirit weeks were still used for games, but other spirit weeks were added for special occasions such as Christmas. This year quite a few people besides the cheerleaders even participated.

Football players started out the year by shaving their jersey numbers on

their heads and keeping this style through the entire season. Next came the "Bleacher Creatures" with their maroon and gold painted faces. This group helped with cheers and even led the audience in the national anthem before games.

EHS's spirit level has gone from below zero to almost 100% participation. The question is "Where Do We Go From Here?!"



Jim Wilson, assistant principal, shows true school spirit while making his rounds to keep the students out of trouble.



EHS's Bleacher Creatures introduced their own brand of spirit at many of the Lady Mustangs' volleyball games.



Seniors Sara Carreander, Ty Czeschin, and Cindy Atteberry switched places with each other while dressing up for Opposite Sex Day.



The Marching Mustangs help raise school spirit by playing pep music in parades and at ball games.



What did you hate about entering high school?







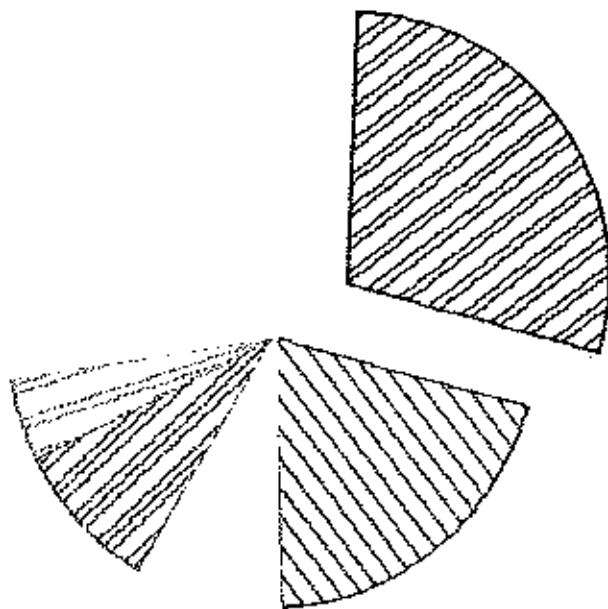

"I thought Mr. Matzen was the boogie-man, but he turned out to be quite nice," stated senior Stacey Fair.

Freshman Mackie Teegarden commented, "The girls don't even look at you because they are more interested in older guys with cars."



Showing true spirit while dressed up as clowns are sophomore Talissa Dummermuth and junior Brandon Cornaby.



-  29% Being at the bottom
-  20% Seniors
-  9% Fitting in
-  9% Getting lost
-  5% Initiation
-  28% Other

Students go to Lake for variety

The Lake of the Ozarks is the closest town with enough activities to keep EHS students busy during their free time. It's also a place to take a date, or even meet new people.

In the summer, "the strip" is packed. People can play video games, eat junk food, shop, visit a haunted house, and go on "the boat."

Lots of Eldon teens work there in the summer. Jobs can be found on the strip, at restaurants, and at the Stonecrest or Osage Village Factory Merchants' Malls.

Miniature golf, water-slides, Big Surf, and go-karts are still popular, but once all that's done, "Where Do We Go From Here?!"



Senior Stacy Fair spent her summer working as a shoe salesperson in the Nike outlet at the Lake.

Dogpatch offers a variety of fun activities to keep a summer night full of both fun and adventure.

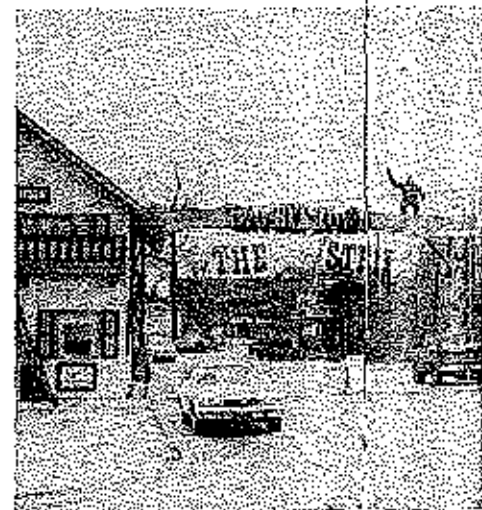
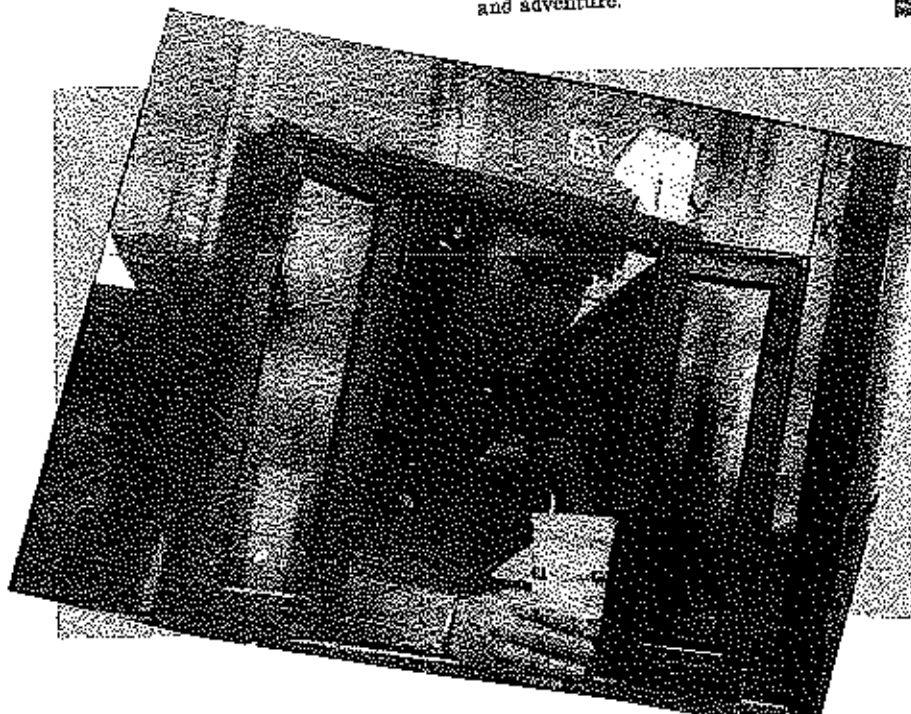

Senior Greg Hand gives service with a smile while working the Taco Bell drive-thru at the Lake.

At Two active couples

The Factory Merchant's Mall provides a full day's worth of shopping and recreation, plus an ice cream shop for a quick snack between stores.



Should girls ask guys out?



Freshman Melanie Spalding said, "Yes, because a lot of girls like guys that would never give them a second glance unless the girl made the first move."



"Yes, because the girls have it too easy," stated senior Chris Parr. "They should have to go through the stress of asking for a date."

NO (29.0%)

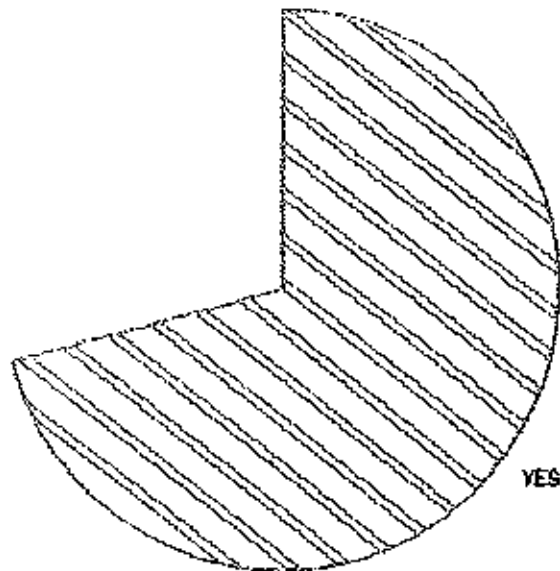

YES (71.0%)

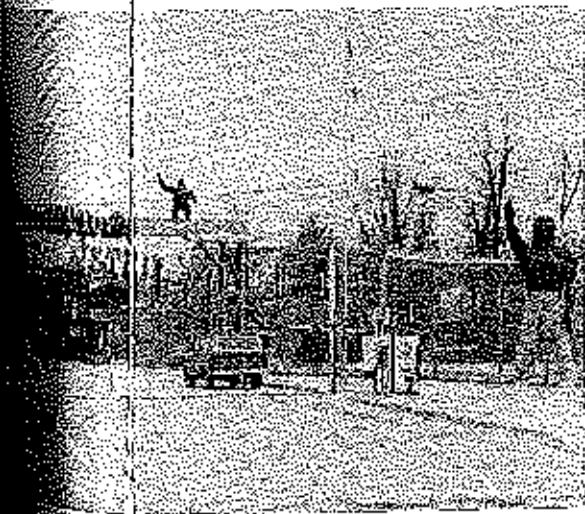

At Two-Bit Town there is a variety of fun activities for a whole family or even a couple on a date.

Homecoming brings excitement to EHS

This year's annual football homecoming came a little earlier than usual, but all went just as smoothly. Floats were finished on time, queen candidates were nominated, and the football team even brought in their first victory of the season.

The festivities began with Spirit Week. Instead of Monday, Tuesday, etc . . . , the days of the week were renamed as: Auto-graph T-Shirt Day, Oppo-

site-Dress Day, Concert T-Shirt Day, Twin Day, and Maroon and Gold Day. On Friday afternoon the cheerleaders gave a pep assembly while the parade was being lined up.

Student Council members decided on "Power Tools" as the theme for the parade. Winners from the organization category were: third place, SLASH; second place, FTA; and once again FFA came in first with "Nail 'Em."

"It was a very exciting experience and definitely one of the highlights of my senior year," commented Jessica Oswald after being crowned.

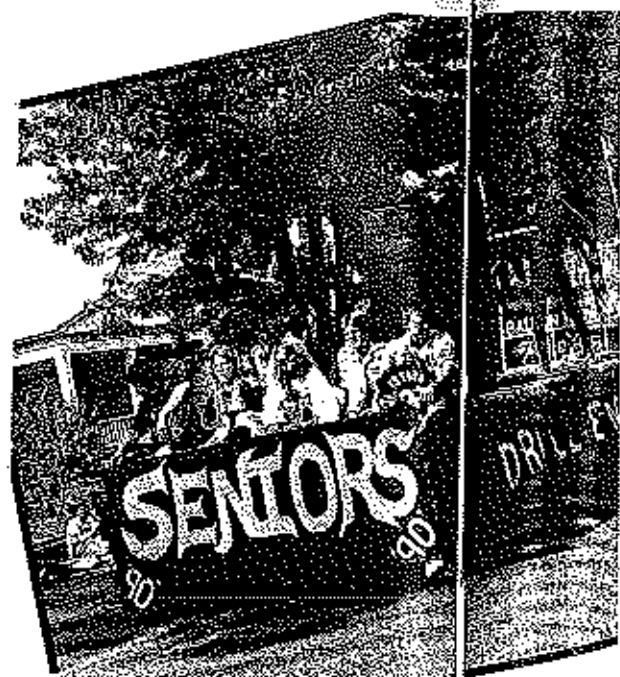

Senior Jessica Oswald happily accepted the honor of being named the 1989 Homecoming Queen for the football season.

A group of senior winning float during the homecoming parade.



Melinda Wrye, Kierstan Jones, Lisa Breshears, retiring queen Tabatha Scott, Carla Furdom, and Jessica Oswald pause for a few quick snapshots before getting in their cars to begin the parade.

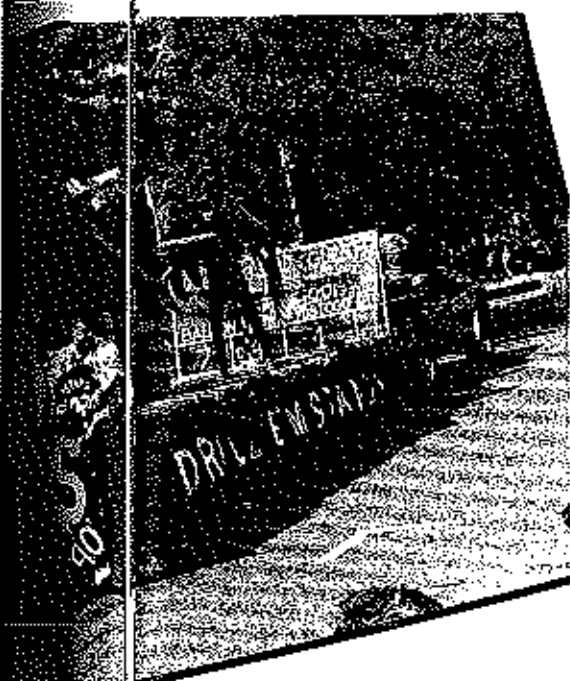

A group of seniors proudly show off the winning float in the class category during the homecoming parade.

Classes placed as follows: third place, juniors; second place, sophomores; and, for the third year in a row, the class of 1990 won the competition with "Drill 'Em," featuring their "Black & Decker Cardinal Wrecker" drill.

At 7:30 Friday night, the Mustangs put a halt to their losing streak. After two quarters, the score was 19-0 in Eldon's favor. Twelve of those points were earned in the first quarter.

During halftime, the queen candidates were driven out onto the field. The nominee for the freshman class was Melinda Wrye; the sophomore class,

Should There Be A Homecoming King?



"Yes, because it would represent both sexes rather than just the girls," commented junior Steve McDonald.

"Most definitely! Then the king and queen candidates could escort each other," said sophomore Mendy Webery.

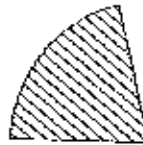

Kierstan Jones; the junior class, Jessica Oswald; and the senior class, both Lisa Breshears and Carla Furdom. Tabatha Scott, the 1988 football homecoming queen, passed her title on to Oswald. The Marching Mustangs then performed their field show.

The last half of the game produced two more points for Eldon, leaving the Mustangs with a score of 21-0 over the Tipton Cardinals. A dance for all students and alumni immediately followed the football game to bring a final close to the 1989 homecoming celebration.

Three p.m. takes students cruising

After spending seven hours locked away in a school building, students at EHS don't go straight home and hit the books. After school is the time to goof around and have a little fun.

By 3:15 the road between the high school and Wal-Mart is jam-packed with cars full of kids trying to find out what's going on that evening. To get out of the traffic, just about everyone from the high school can be found either at the Cree-Mee or the Drive-In. After a chili-cheese dog and a soda, it's back to cruising for a while before heading home.

Planning the evening is always left for after school. The one thing everybody wants to know is "Where Do We Go From Here?!"



Senior Kyle McFadyen leisurely waits for the action to pick up after school at the Cree-Mee.

When school lets out, the line of cars at the stoplight stretches on for blocks between the school and Wal-Mart.

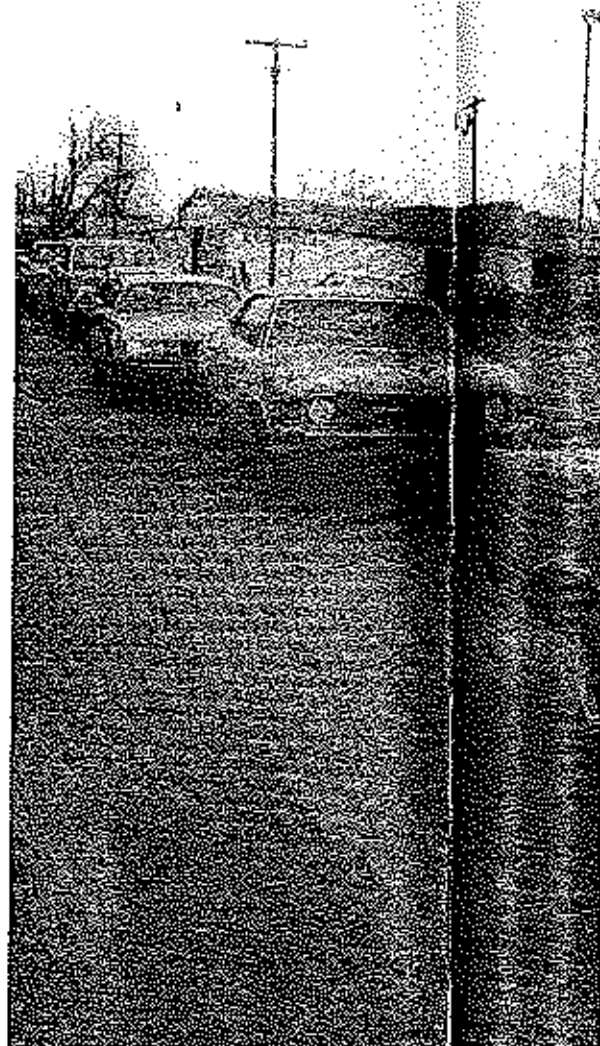

Talking over the events to take place that night are juniors Steve McDonald and Daria Bond.



At cheerleader Misha Olin

Like many EHS students, junior Tisa Pope spends much of her free time working. She is employed at Gerbes and spends most of her time in the bakery.

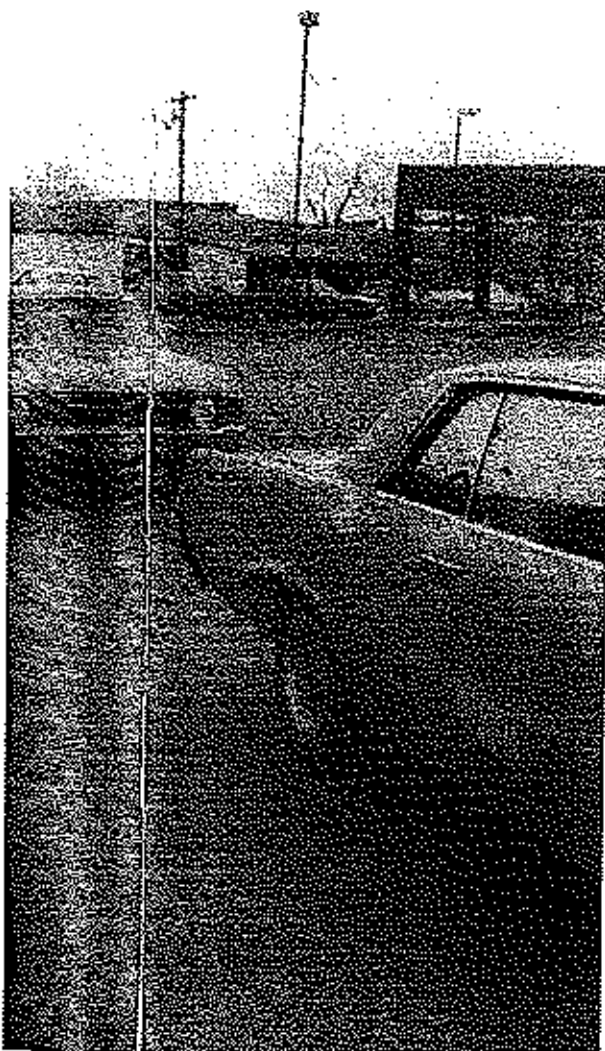

What do you do after school?



"While some people are having fun cruising around, some of us have to give up our free time and work," stated senior Amanda Herden.



"After school I like to cruise around town and listen to see whose stereo blumps the loudest," remarked junior Jordan Langley.

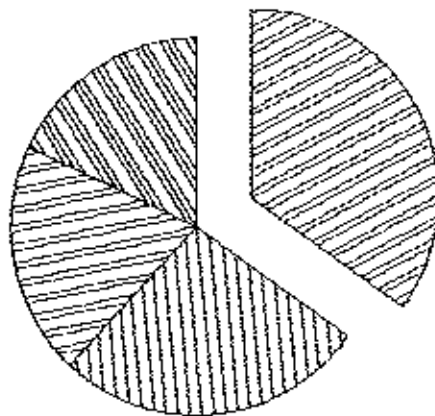

35% cruise

27% practice

20% work

18% home



At cheerleading practice after school, sophomore Heather Hayes and junior Misha Ginsert rehearse a dance.

Take place
at McDon-

High school life really begins at age sixteen

SIXTEEN!! In high school, that's when the real fun begins. Along with the age comes a license, which comes with the chance to get out of the house and into the action. The only way to reach this early is to have a friend who turns the magical age first.



Santa was extremely generous to both junior Brian Rogers and his sister, senior Deanna Rogers.



Putt, putt goes senior Jenny Ressel and freshman Jamie Ressel in her little car named "Fiesta."

Sophomore Joe Hoffner stops cruising Eldon's strip just long enough to fill up his car with gas.

Of course, there are a few problems. A job is now needed to pay for things like gas, insurance, etc . . .

But at least now the new driver can finally ask, "Where Do We Go From Here?!"

Having a car takes lots of money, as many teenagers, including junior Kim Zupancic, have learned.



MINI MAG



The question is thought of quite often, "Where do we go from here?!" The Mini Mag is part of the yearbook that brings out where we've been, where we are now, and where we might go.



en

both jun-
senior

al and
to car

ing El-
up his

What was your view
about the Manuel
Noriega situation in
Panama?



Manuel Noriega committed a
great injustice to his own people
of the United States. He had a
great responsibility that became
clouded with the drug problem.
The power to run a country
should of been used wisely not
simply for his own personal
gain.

Tyrus Czeschin



HERE'S LOOKING

1980



1982



1984

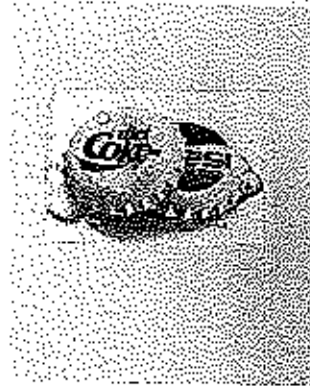

1986



1981



1983



1985



1987



DRUG LORDS FALL

Panamanian dictator
Manuel Noriega was in-
dicted for drug trafficking
charges in February 1988.
U. S. officials confidently
predicted that he would
soon be swept from power.
When that failed to hap-
pen American authorities
imposed economic sanc-
tions on Panama designed
to cripple the country and
trigger a popular uprising.
No luck there. With

Washington's blessings,
Panamanian opposition
parties hoped to use the
national elections last
May to unseat Noriega's
cronies in the government.
Noriega moved constant-
ly, never staying in the
same place two nights in a
row. They say that he was
so fearful of being poi-
soned that he allowed only
his mother and mistress to
prepare his meals. By

turns, he reportedly flies
in fits of rage and then
sinks into drunken de-
pression. "Noriega doesn't
know who to trust," say a
foreign-policy analyst in
Washington. "Next time
there's a coup, he's a dead
man."

In November, word
leaked out that the Bush
Administration had ap-
proved \$3 million for the
Central Intelligence Agen-

cy to recruit Panamanian
military men and exiles to
take another shot at top-
pling Noriega. Washing-
ton also signaled that it
will soon impose a new set
of economic sanctions on
the country.

TH

Jim
respe
Evange
leader
prison
ted of f
Baker
follow
their d
The fu
his own
stead of
Baker
forty-

AT THE 80'S

1986



1988



1990



1987



1989



WHERE
DO WE
GO
FROM
HERE!?

What was the most exciting thing that you liked during the 80's?



I'm glad that we don't wear polyester plaid and polyester brown suits with peace polkadots.

-Jonny Rossel



THE WALLS COME DOWN

Jim Baker, The highly respected Public TV Evangelist and PTL Club leader was sentenced to prison after being convicted of fraud this past year. Baker misrepresented his followers by not using their donations properly. The funds were used for his own personal use instead of the good of others. Baker will spend the next forty-five years in prison

serving for his wrong doings. But what about Tammy Fay? How come she doesn't have to serve some time as well? Wasn't she involved just as much as Jim was?

The Berlin Wall, which only took forty-eight hours to build, has stood for twenty-eight long years separating the German people. The Berlin wall symbolized the bleak

outlook for the reunification of Germany as one country. In November of 1989 the leader of East Germany brought the wall tumbling down. The Berlin Wall, which was built to last forever, has symbolized the separation of communism from Democracy. It's fall will hopefully show a trend for the nations of the world to become peaceful neighbors.

Romanian
exiles to
at top-
washed-
that it
new set
tions on

Are you ever scared there'll be a quake in Missouri?

SIGNS TO

ARIES
March 21 - April 19

Don't skip school without a reason or you'll have to come back in the summer season.

TAURUS
April 20 - May 20

Caught in the halls without a pass... better watch out.

GEMINI
May 21 - June 20

Better watch out because that 4th tardy is comin' and then you'll be visiting Mr. Youmans.

LIBRA
Sept. 23 - Oct. 23

The term paper to pass as you soon be discomfited soon will be known.

CANCER
June 21 - July 22

When the summer months grow near, the four inch rule is here.

LEO
July 23 - August 22

If you have a soda, better drink it fast because ISS is near.

VIRGO
Aug. 23 - Sept. 22

Mr. Wilson is always there, so whenever you turn around watch out and beware.

CAPRICORN
Dec. 22 - Jan. 19

Sometimes you get real mad let a teacher hear you could get bad.



It really scares me to think that there will be an earthquake right here were I live. I just hope we're all prepared for it.

-Jynne Henley

THE BIG ONE

In a matter of seconds, an earthquake measuring 7.5 on the Richter scale struck the Hayward area, just across the bay from San Francisco. At least 4,000 people were killed; three times as many required urgent medical attention.

The quake knocked out electric power, phone lines, and water supplies. Bridges crumbled, sagged and the Nimitz Freeway collapsed, shown in the picture above. Despite all the chaos and destruction, San Francisco had some lucky breaks; it took place during the night, and neither wind nor rain kept rescuers from succeeding.

It has been said that the big one is yet to come and it'll hit here in Missouri within the next 30 years.



YOUR FUTURE

LIBRA
Sept. 23 - Oct. 22

The term paper you tried to pass as your own will soon be discovered and soon will be known.

SCORPIO
Oct. 23 - Nov. 21

Picking that fight in the parking lot, will get you more punishment than the black eye you got.

SAGITTARIUS
Nov. 22 - Dec. 21

When your trying to embrace you doar, don't get caught because counseling is near.

CAPRICORN
Dec. 22 - Jan. 19

Sometimes you cuss when you get real mad but don't let a teacher hear 'cause it could get bad.

AQUARIUS
Jan. 20 - Feb. 18

Put away that cigarette pack, 'cause when they take 'em away you won't get 'em back.

PISCES
Feb. 19 - Mar. 20

During Study Hall put your cards away, because if you play they'll take 'em away.

Why do you like listening to the horoscopes every morning?



I like to hear what's supposed to happen to me and to see if it'll come true.
-Shannon Schekorra

MUSIC MATCH-UP

- | | | |
|--------------------|-------------------|------------------------|
| A. Aerosmith | 1. Daniel Ash | a. And Justice For All |
| B. Cinderella | 2. Ian Astbury | b. Coming Home |
| C. The Cult | 3. Sebastian Bach | c. Cult of Personality |
| D. The Cure | 4. Bono | d. Desire |
| E. FYC | 5. Anthony Corder | e. Down Boys |
| F. Guns N' Roses | 6. Danny Elfman | f. Dr. Feelgood |
| G. Junkyard | 7. Roland Gift | g. Talk Dirty To Me |
| H. Little Caesar | 8. Corey Glover | h. Flesh 'N Blood |
| I. Living Colour | 9. James Hetfield | i. Good Thing |
| J. Love 'N Rockets | 10. Tom Keifer | j. Heaven's Trail |
| K. Metallica | 11. Jeff Keith | k. Hollywood |
| L. Motley Crue | 12. Jani Lane | l. Little Fighter |
| M. Oingo Boingo | 13. Bret Michaels | m. Love in an Elevator |
| N. Poison | 14. Vince Neil | n. Love Song |
| O. Skid Row | 15. David Roach | o. Name Your Poison |
| P. Tesla | 16. W. Axl Rose | |
| Q. Tora Tora | 17. Robert Smith | p. Patience |
| R. U2 | 18. Mike Tramp | q. So Alive |
| S. Warrant | 19. Steven Tyler | r. Sun King |
| T. White Lion | 20. Ron Young | s. Walkin' Shoes |
| | | t. 18 and Life |

IT'S YOUR FAVORITE



CANDY BARS

- 1 Snickers
- 2 Reecos
- 3 Whatchamacallit
- 4 Skor
- 5 M & M's
- 6 Twix
- 7 Mounds
- 8 Bar None
- 9 3 Musketeers
- 10 Babe Ruth



SINGER

- 1 Alice Cooper
- 2 Richard Marx
- 3 Jon Bon Jovi
- 4 Phil Collins
- 5 Rod Stewart
- 6 Paula Abdul
- 7 Belinda Carlisle
- 8 Whitney Houston
- 9 Madonna
- 10 Debbie Gibson

MOVIES

- 1 Batman
- 2 Look Who's Talkin
- 3 Lethal Weapon II
- 4 Rainman
- 5 Naked Gun
- 6 16 Candles
- 7 Dirty Dancing
- 8 Beaches
- 9 Lost Boys
- 10 Bill and Ted



ACTOR ACTOR

- 1 Tom Cruise
- 2 Eddie Murphy
- 3 Kirk Cameron
- 4 Michael Keaton
- 5 Paul Newman
- 6 Kirstie Alley
- 7 Kim Basinger
- 8 Meg Ryan
- 9 Molly Ringwald
- 10 Bette Midler



A PLACE TO STUDY

Study Hall ... Library or Cafeteria, which do you choose? Choose the library because it is quiet and they can study, others choose the cafeteria.

In the cafeteria there is a more relaxed atmosphere. Students can drink sodas or eat candy bars and chips. The students that have a study hall in the library have a better chance of getting their work done, but those in the cafeteria might have more trouble.

Instead of studying in the cafeteria, students talk, gossip, eat, sleep, or just sit and

do nothing. The objective of a study hall is to study, but what students choose to do is their own decision.



Marcia Milburn, Sophomore, finishes her World Civ. worksheet and Senior, Jerry Wood watches.

Junior, Darin Bond, works frantically on his Algebra II problems.

er
farx
ovi
is
rt
ul
arlisle
ouston

bson



er World
tches.
e Algebra

PEOPLE



Where do students from EHS go? Some go anywhere from Jefferson City to the Lake to find entertainment, a place to take a date or just to waste time. At Jefferson City during the winter, some of the most popular places to go are the movie theatres, the shopping mall and a variety of restaurants. During the summer at the Lake of the Ozarks, the various things to do are boating and skiing, parasailing, riding the Hanoi Cruise and cruising the strip.

Where do graduates from EHS go after high school? Many choose to attend college, while others choose to go straight into the business world.

WHERE DO WE GO?
CONTRIBUTOR

Administration Keeps Eldon High School In Order

The backbone behind the Eldon High School is the administrative staff. They work hard to keep everything working in an orderly fashion. Their day rarely ends at 3:30 pm.

The staff consists

of the superintendent, administrative assistant, principals and counselors. The hours spent in keeping the school system functioning properly is phenomenal.

Superintendent Walter Mooney keeps everything in order for the upcoming 1990-1991 school year. Mooney is in charge of budgeting and the overall educational plan for the district.

Mr. Jim Wilson, assistant principal, administers discipline and assists the principal in his daily duties.

Mr. Jim Guilford, principal, enforces policy and student behavior.

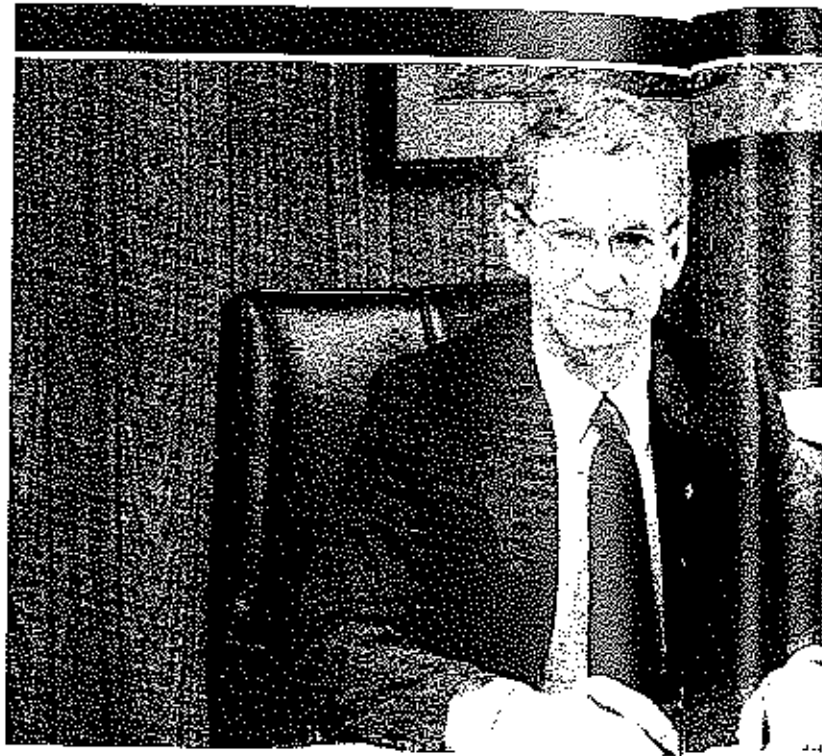

TOP PICTURE: Members of the Board of Education are; first row, Carol Newton, Jim McDonald. Standing: Dale Dunstan, Dennis McDevitt, Rob Frazee, Jerry Frye.

MIDDLE PICTURE: June Bruner, head of curriculum activities, keeps busy at her desk. RIGHT: Mrs. Fran Bachant and Mrs. Carolyn Deffenbaugh make sure class schedules are in order and senior get their college applications filled out and sent off.

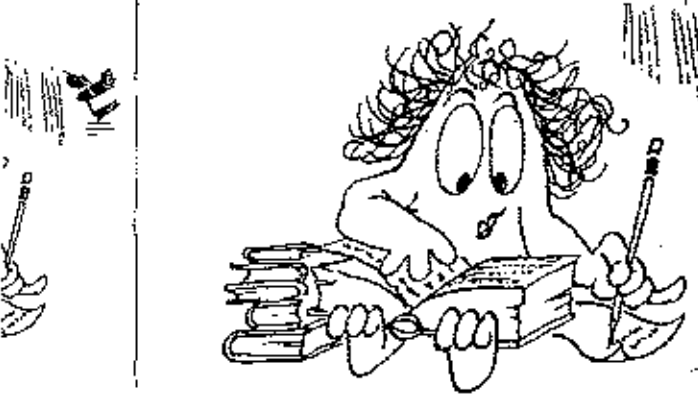
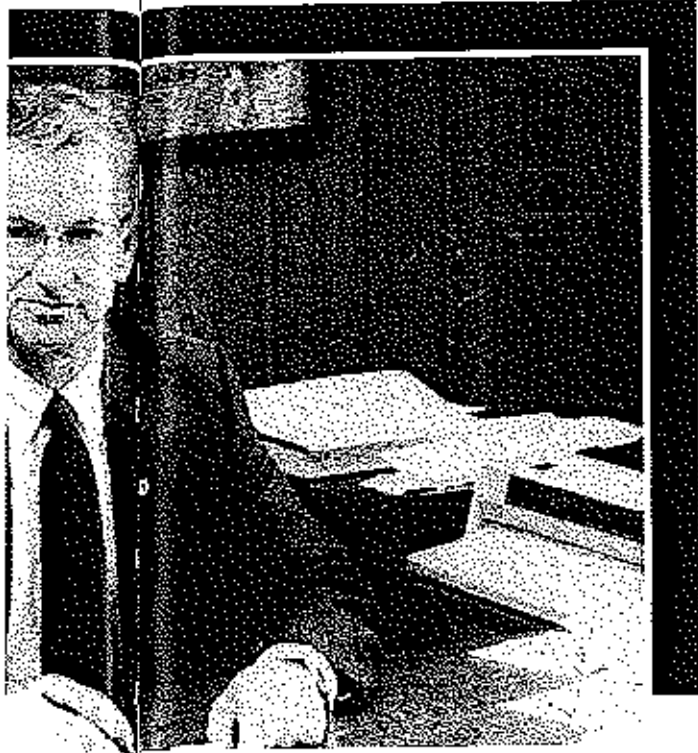

MEMBER: Member of Education Board, Jim... Standing: ...a, Dennis... and Frazee,



PICTURE: ...Lead of activities, ...her desk. ... Fran ... Carolyn ...gh make schedules and senior ...lege appli- ...out and

Staff: the Backbone of Eldon High School

The staff of Eldon High are the ones who keep the building clean, make sure we have a nutritional lunch, and keep all the office work in order. They are the backbone of our school.

Who could these people be? Why they are the secretaries, janitors, and cooks.

The EHS secretaries are Ava Hill is the secretary to the Assistant Principal, Jim Wilson. Linda Hammond is the secretary to the Princi-

pal, Jim Guilford. Betty Fisher is the secretary to counselors.

The janitors are the part of the staff who make sure the school buildings are clean and spotless. The janitorial staff consists of Glenn Hammond, Bob Boor, Tony Kovac, Richard Dinwiddie, and Darrel Buechter.

Roma Boatman is the head cook who keeps the lunch room in order.



RIGHT - Linda Hammond, secretary to the principal. BELOW - Ava Hill, secretary to the asst principal. FAR RIGHT - Tony Kovac keeps the south wing of the high school building running.





ABOVE - Nona makes sure everyone's hand in their hand tickets. ABOVE - Glenn Hammond cleans the west wing of the school building. FAR ABOVE - Betty Fischer is busy making sure everything is ready for school.

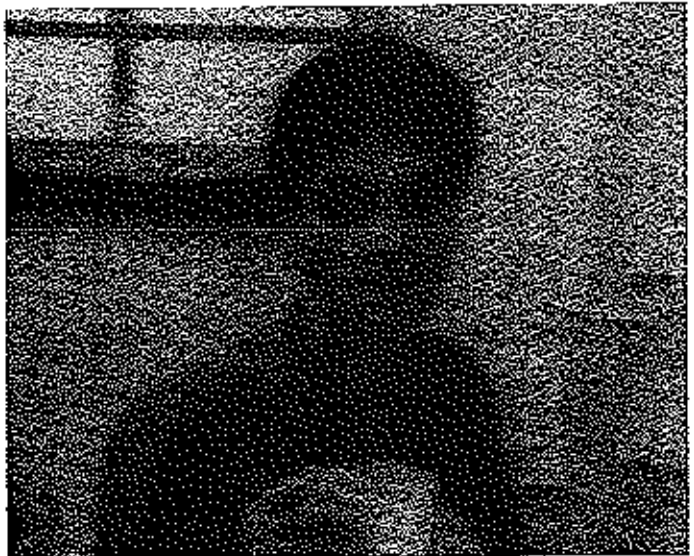

Paving the way to our future

David Bailey, English
 Matthew Biddle, Agriculture
 Carrie Burchett, Vocal Music
 Chuck Campbell, Marketing
 Mary Conoannon, Special Education



Rosemead Connell, Spanish
 Jane Crow, Sciences
 Carolyn Deffenbaugh, Counselor
 Richard Eastin, Art
 Betty Fisher, Secretary



Jim Guilford, Principal
 Willard Haley, Agriculture
 Glen Hammond, Custodian
 Linda Hammond, Secretary
 Clare Harriman, Girls P. E.



Where do
 here? This
 frequently a
 teachers at
 full and
 school yes
 back to sch
 summer m
 choose to t
 and job for
 Some luck
 even get the
 tax and enj
 mer vacatio
 If we are
 will all be
 the fall to st
 1991 schoo
 time Eldor
 of excellen
 tion.

What do you plan on doing during the summer months?

"I always work at Holiday Inn . . . trading school work and activities for the privilege of watching and dealing with Stupid Tourist Tricks!" quoted English teacher Chris Spencer.



"I will teach at Missouri Scholars Academy for three weeks and then spend the rest of the summer enjoying my family." stated Science teacher Connie Wyrick.



"I will be teaching summer school and playing with my now son!" said David Bailey, English Teacher.



TEACHERS



What we look forward to . . .

Students took a variety of classes during the past year. According to the guidance office, students were more involved in Home Economics classes and were even using their study halls wisely.

EHS offers a varied curriculum that allows students to take courses in both vocational and college preparatory areas.

Students may take such elective classes as Speech which helps the students learn to be more comfortable talking or just getting up in front of people expressing how they feel.

This year for the first time, the science department offered a course for those wishing to learn techniques of science research. Connie Wyrick, teacher of this new class said, "This class is designed to allow Science oriented students an opportunity to investigate any topic of their choice." Several students had an opportunity to work with professors throughout the state. Some of the projects involved were the use of electron microscopes and other advanced equipment not found within our own department. "I am glad there was such a big turnout of people taking this course," said Wyrick.

Sophomore, Jolene Van Hooser said, "In College Prep Biology we do a lot more stuff in the lab and that makes it more interesting than sitting in the classroom the whole year."

This years students now have the opportunity

to work for a different diploma than before. It's a College Preparatory Certificate that students may elect to work toward.

David Bailey's Drama class consisted of more underclassmen this year than before. Despite their lack of experience this class gave two outstanding performances this season. Bailey said, "It was a young enthusiastic group, which will continue to provide lots of talent in years to come."

This past year there was also a new opportunity open to Juniors who wished to take an Honors Algebra course first semester and Trigonometry second semester. During their senior year these students can take Calculus. Merle Matzen teaches both of these classes.

Linda Simon's Family Living class offers students a realistic outlook of parenthood and as an adult living on their own. It makes people realize the difficulties in real life and that it's not all happy endings like on T. V. soaps.



←Clothing is a they wis instance for White ironing.

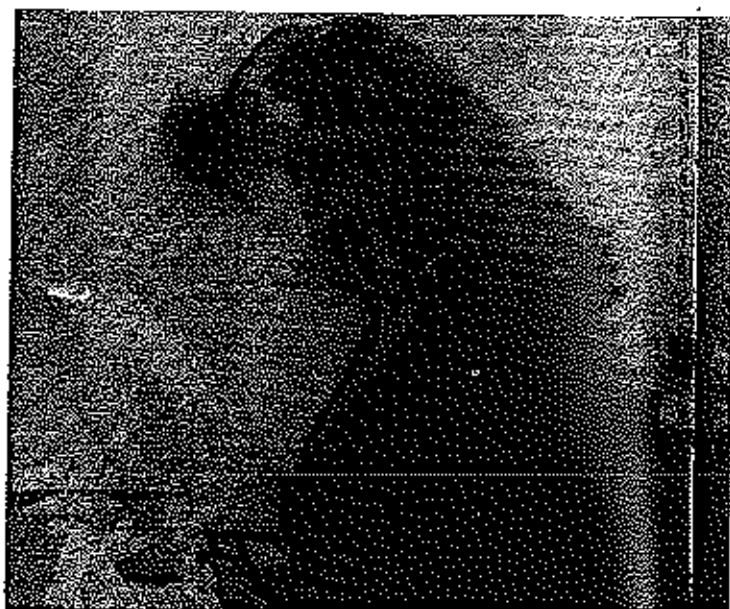

←In her demonstration speech, sophomore, Christie Martin teaches Kyle MacFadyen, who has never ridden one, how to sit a horse. Kyle said, "It was a lot of fun and I was sore afterward from straddling the horse."



«*Clothing I can* teach students a few things whether they wish to sew or not. For instance sophomore, Jennifer White now can use the ironing skills she learned.

«*While taking a typing test* Junior, Ginny Withia, and Junior, Holly Forester hoped that they did their very best as they listened to Cortez W. Peters (the famous typist). This class was taught by Sonja Campbell.



«*Senior, Tina Wilson* learned how to construct a garment in Mrs. Ludjke's Clothing I class. This class consisted of all girls wanting to learn the basics of making clothes and fixing torn garments for use in the future.

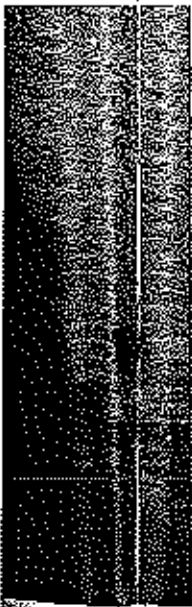

«*Teaches a horse on strad-*



«*Junior, Shelly Cole* said, "At first it was hard to get up in front of a classroom full of people but when Mr. Bailey had everyone give an introductory speech it made it a lot easier to get up in front of total strangers for try-outs and pep assemblies."

«*During cafeteria study hall*, sophomore, Marcia Milburn, and senior, Jerry Wood are actually taking a cafeteria study hall seriously. They studied instead of having a good time sitting around gossiping, eating, and drinking.

Electrifying

At the beginning of every year, freshmen enter High School with a light stomach and shaky knees, and then realize at the end of the day it wasn't all that bad after all. All freshmen are required to take Physical Science, P. E., American Literature, Civics, and a math course. In Physical Science the students learn about gravitation, electricity, magnetism, and levitation, along with all the different functions of each of them. To do so, Mrs. Crow has the students perform experiments. In the experiment to the right, freshman, Landon Albertson hooked wires to his braces, to a battery, and then to a light bulb to see just how far electricity can and will flow. The electric flow did light the bulb.

P. E., another requirement, gives freshmen a chance to see what kinds of different sports they like and if they want to participate in sports throughout their High School career.

Mr. Norman teaches the Government and Economics/ Youth and Law. It gives the students an outlook on the way government is operated and how the law is enforced.

The sophomores are required to take classes too but not as many. American Novel, American Literature, a math course and World Civilization are their required subjects. Most people feel that after the freshman year all one has left is three more years but they go by slowly for some people and quickly for others.

During the junior year students aren't required to take very many classes at all, but by this time students are more concerned with how many credits they have earned and what classes they still need to take. The only requirement is American History.

Finally, in the senior year students can construct their own schedule and take what he wants to every hour. RHS students need twenty-three credits to graduate and can have more. Filling out schedules, students can often be heard saying, "Where do we go from here?!"

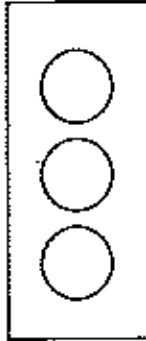

Seniors, Calvin Taylor and Joe Martin work hard on their art projects to get them done on time for Mr. Martin.

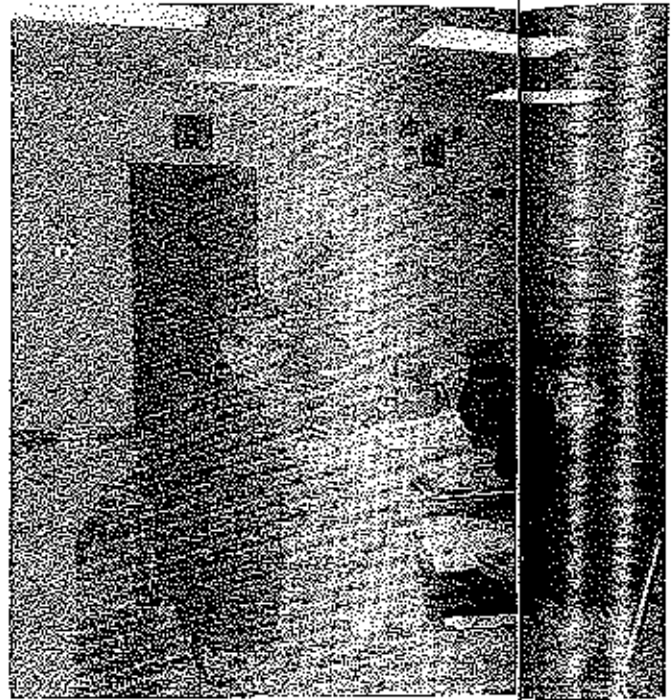

Junior, Brandon Cornaby gets some helpful information from Mr. Bailey on his debate topic as he prepares for an upcoming debate tournament.

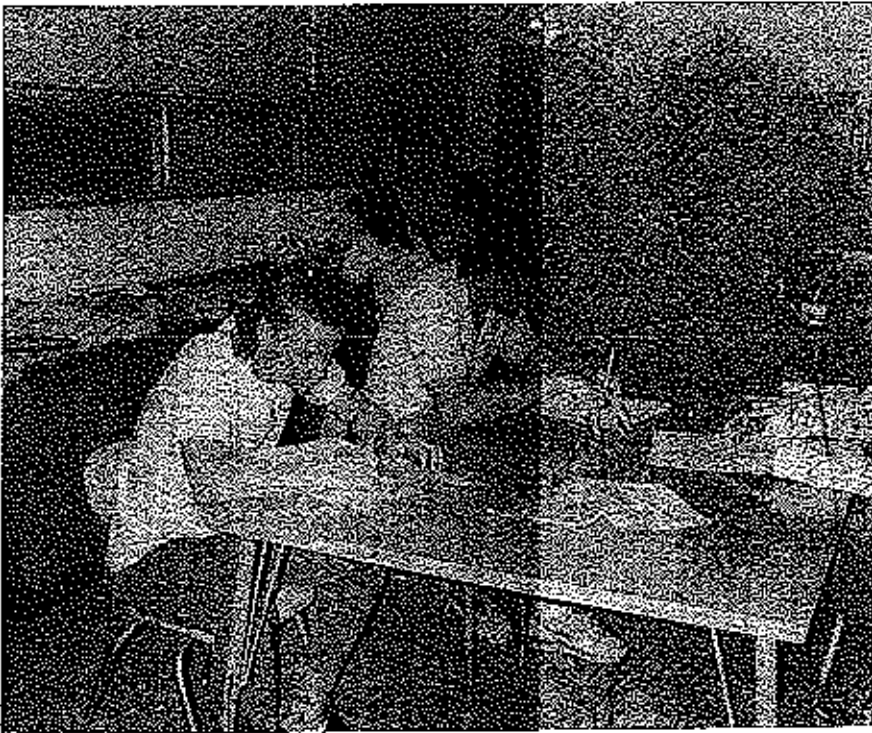

*Junior, Janice Myers, concentrates on her art project in order to draw the best picture that she can.

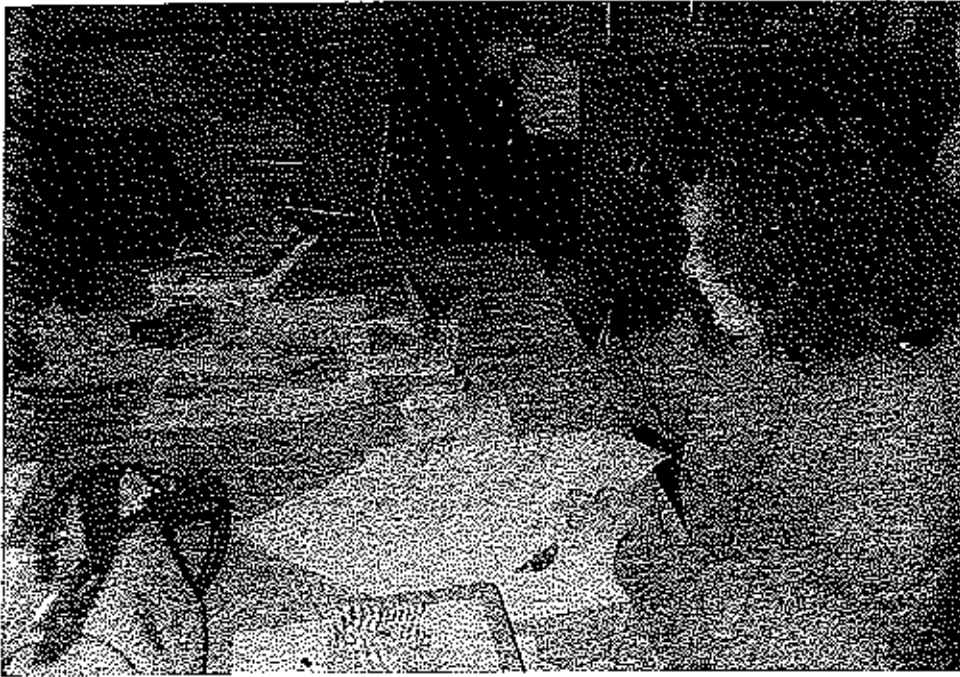

*Senior, Travis Rader sits in the hall to make up a World Civilization test after being absent the day before.

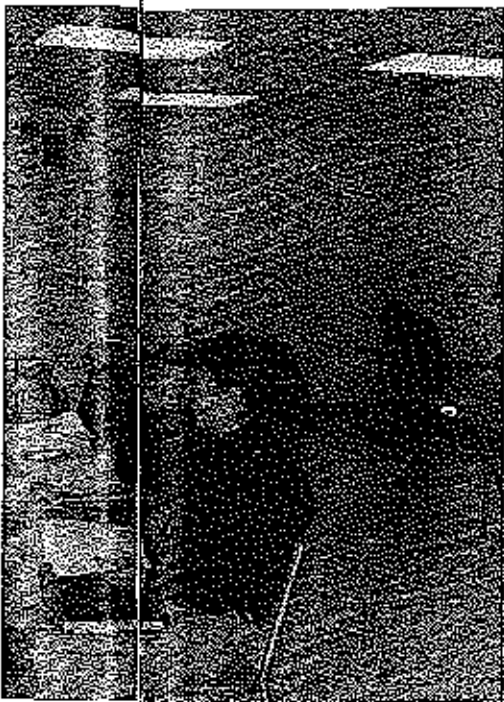

plai infor-
to topic as
be tourna-

*Sophomore, J. R. Tucker is sweeping off the stage to get extra credit points from Mr. Bailey in American Literature.



From the Start

Shannon Abbott
Landon Albertson
Donald Alden
Jack Amos
Matt Amsinger
Amanda Apperson



Misty Banner
Christina Barfield
Bob Barker
Bobby Blanchette
Jennifer Bonafacio
Wendy Booth



Ernie Boots
Angela Borghardt
Billy Bortea
Jason Bowen
Michael Branstetter
Mary Brown



Judy Bryant
Jeremy Bunch
Seth Bunch
Todd Burris
Rosie Butler
Sam Carsender



ALBERTSON ALDEN AMOS APPERSON BANNER BARFIELD BARKER BLANCHETTE BONAFACIO BOOTH BOWEN BOWEN BRANSTETTER BROWN BURRIS BUTLER CARSENDER

Fresh

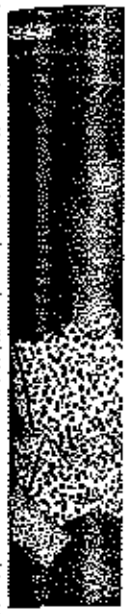

Freshman watched as Eldon defeated California in the homecoming game.



SCHOOL CROSSING

Freshman Class Officers



SHARP RIGHT TURN

Freshman class officers are: Reagan Facemire, Vice-President; Brock Czeschin, President; and Stephanie Hammond, Secretary-Treasurer. Their main responsibilities were building their class homecoming float and participating in all Student Council activities.

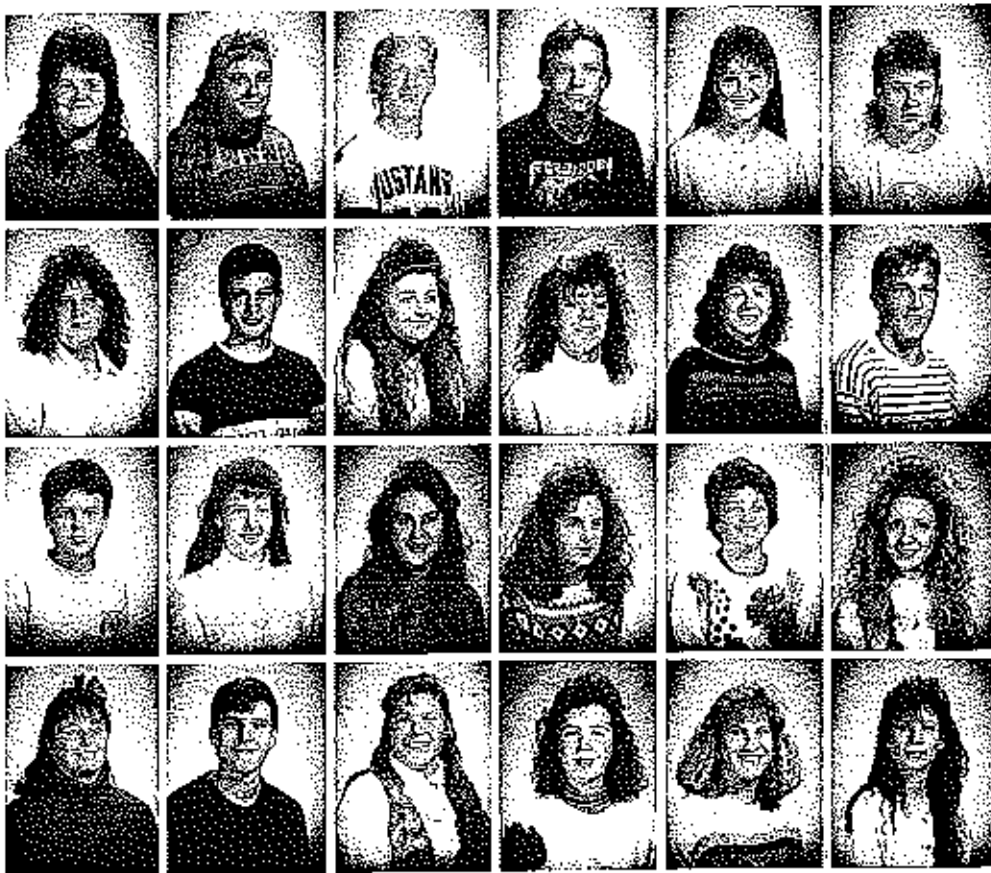

Janice Clark
Jennifer Clark
Ty Cobb
John Coffman
Samantha Cornett
Joey Counts

Julie Crouch
Brock Czeschin
Leslie Davenport
Novenda Deboer
Heather Dinwiddie
Matt Dolby

Corey Eicher
Suzan Eidson
Sheryl Eth
Reagan Facemire
Tasha Farley
Amy Flaughter

Robin Francis
Harold Franken
Denise Gibson
Kimberly Green
Holly Griswold
Hope Haggerman

Freshman . . .

Stephanie Hammond
Joshua Harvey
Heather Hayes
Susan Hanley
Eric Hibdon
April Hill



Tonya Hodge
Phillip Holland
Scott Hollis
Kari Holtmeyer
Melissa Horton
Chad Hughey



Melissa Hull
Phonessavan Ingharaphat
Jill Jones
Tonya Jones
Masy Kirkpatrick
Carrie Kitcher



Nancy Klug
Curtis Koop
Jon Lambeth
April Laswell
Michael Lee
Billy Liebrum



Freshman, I
Hayes work
Judy Baysan
where but a



What was the best thing about entering high school?

"There are a lot more activities than junior high and you see a lot more fights after school," said Freshman, Matt Dolby.



Another freshman, Leslie Davenport stated "You get to do more of what you want."

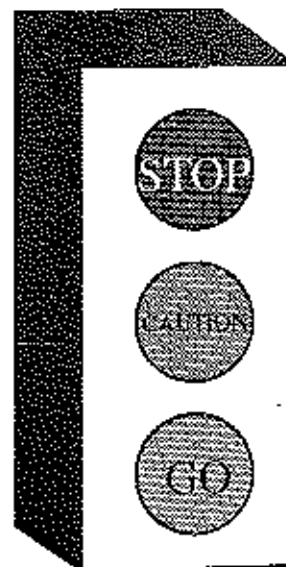

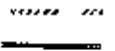

OP

TH

O



Freshman, Lance Nations, Christina Darfield and Heather Hayes work on their homework, while in the back row Judy Bryant and Gwen Morris daydream of being anywhere but school.



Freshman, Brad McDowell concentration his art project for Art I.

MARK LITTLE JENNIFER LOVELACE RACHEL MARTIN APRIL MASTERS KIM MAYFIELD RUSSELL MCDOWELL



Mark Little
Jennifer Lovelace
Rachel Martin
April Masters
Kim Mayfield
Russell McDowell



Michael McGrail
Heather Medina
Heidi Madlin
Marshall Medlock
Angie Miller
Gwen Morris



Hollie Morris
Shawn Moyer
Jimmy Myers
Lance Nations
Dana Nichols
John Nowack



Travis Opie
Angie Oster
Jason Owen
Eric Pearson
Laura Pemberton
Jennifer Pittrich



Jill Jones and Misty Banner, freshmen, sell popcorn at a home game for FFA.

PHOTOGRAPHY BY JILL JONES AND MISTY BANNER



Jason Taylor
Mackie Teegarden
Cathy Thorson
Melissa Tindall
Karisa Tompkins
Chady Trenary



Robert Turner
Holly Tuttle
Leah Twyman
Gary Vaughan
Richard Vaughan
Garrett Vaughan



Robert Wall
Chris Wardenburg
Amy Whittle
Heather Willis
Junior Wine
Mike Witt



Darreca Wood
Lisa Wright

Not pictured are: Scott Ahart, Steven Baker, Jennifer Bonifacio, Danielle Booth, Chris Brown, James Costello, Curt Feltrop, Mark Frohse, Calvin Gabbard, Jennifer Gerlt, Reann Knasbel, Michael Lexa, Cassandra Matejka, Brandon Opie, James Ressel, Cory Runyan, Amia Schuster, Jason Wake, Travis Whittle.



Famber-
game.

David Abbott
Bob Arnold
Craig Atteberry
Jerod Atteberry
April Ballenger



Adam Barb
Rodney Bashore
Kim Bennett
Brian Berns
Dawn Bond



Chastity Bonnot
Tammy Brooks
Jason Burks
Christy Burris
Thadd Buster



Terri Calo
Dawn Cavender
Lori Christner
Walker Claridge
Aaron Clement



SOPHOMORE'S DRIVING 'EM CRAZY

When you become a sophomore you are no longer the youngest, you are free to choose more of your classes, and for most . . . you earn the privilege to drive.

This privilege can mean going places when you need to, "cruising" town, getting a job, and can even improve your social life.

Driving also has it's downsides, like people you don't know asking for rides, running errands for your parents, paying for gas, and possibly paying for the car.

But is it all worth it? Some sophomores share their views.

It's not that bad chauffeuring those that can't drive because once they see your gas gauge on "E" they don't ride for very long! *Tim Wood*

When it comes to dating I think it's important to have transportation because you aren't going to have much to do if you can't get anywhere. *Dawn Bond*



I enjoyed driving until I learned the hard way that accidents do happen. Unfortunately I learned this lesson twice but neither accident was my fault. *Chris Newton*

It's not really that hard to learn the mechanics of driving, but it is hard trying to stay concentrated not only on what your doing but also on what the other drivers are doing. *Jelene VanHooser*



Christina Frye
Karen Fuernzmaier
Erica Gee
Mark Golden
Dennis Gray



Joe Green
Sean Green
Larry Halderman
Dawn Hawken
Jason Helvey



Steve Henderson
Aaron Hibbon
Joe Hoffner
Amy Howell
Robin Hutcherson



Vitsaphon Intharaphet
Kelly Jeffries
Mike Jeffries
Steve Johnson
Maria Korpker



Bla

On the sop.
theme, "B
Stangs", is
dummy C
moved thro



WILSON WILSON

Chosen as class officers are Connie McDevitt, vice-president; Christie Martin, president; and Stephanie Leivan, secretary/treasurer.



Denise Reed
 Jenny Maid
 Angie Richards
 Chris Roberts
 Kendall Roe



David Saint
 Steve Sanning
 Kelly Schubert
 Angela Schwantes
 Mike Scott



Kevin Schoemaker
 Dixie Sidebottom
 Angela Skoutby
 Josh Smith
 Scott Spears



Jeremy Spratt
 Zane Stevenson
 Dale Stone
 Jason Stuart
 D. J. Taylor



MILLARD MICHIGAN MINNESOTA MISSOURI MONTANA NEBRASKA NEVADA NEW HAMPSHIRE NEW JERSEY NEW YORK NORTH CAROLINA NORTH DAKOTA OHIO OKLAHOMA OREGON PENNSYLVANIA RHODE ISLAND SOUTH CAROLINA SOUTH DAKOTA TEXAS UTAH VERMONT VIRGINIA WASHINGTON WEST VIRGINIA WISCONSIN WYOMING

Gotta a Job may be a responsibility taken on after you get your license. Carhop, Kelly Schubert, serves drinks at a local drive-in.

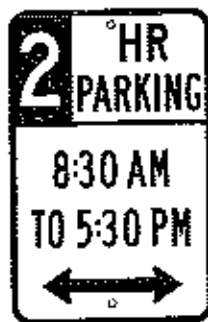



Taking down a float is usually easier than building one, but can be just as much fun. Sophomores, Thadd Buster and Christie Martin, take apart their second place float.



Troy Taylor
J. R. Tucker
Jolene VanHooser
Kyle Waker
Gerald Wall

Rebecka Wallace
Mandy Webery
Amy Webster
Marica Wells
Heather West

Cornelia Wickam
Joy Williams
Chad Wilson
Molly Wirts
Jennifer White

Calin Wood
Shannon Wood
Tim Wood
Matt Wyrick
Allan Yinger

Going On From Here

Shawn Abbott
Nicole Adams
Sean Atwell
Jason Baker
Christy Barr



Mendy Barton
Melissa Bar
Terry Blankenship
Shannon Boatman
Darin Bond



Heith Boyd
Tim Bradley
Troy Branstetter
Kenny Breshears
Virginia Brooks



Michelle Buck
Paul Burris
Bo Claridge
Nicole Clark
Shelia Clark



On
We
Top

The junio
been busy th
lots of plan
hard work. I
teers came
lice with
ions. One
asked was v
from here?
Not only
to build a cl
participate in
and school
do their c



What do you look forward to most about being a Senior?



"It's my last year in this joint!" said Jamie Golden, Junior.



"Getting my way and being able to boss everyone around." stated Junior, Terry Blankenship.



"Getting out of high school and moving on to bigger and better things!" said Meady Davenport, Junior.



On Our Way to the Top!

The junior class has been busy this year with lots of plans and lots of hard work. The class officers came into the office with many questions. One big question asked was where do we go from here?

Not only do they need to build a class float, participate in many clubs and school activities and do their daily school

work; they take on the monumental task of raising money for Prom. They are expected to decorate and make all plans for prom.

At the end of the 1990 school year after all the jobs and tasks are completed, these excited juniors will step forward as the senior class and ask again, Where do we go from here?



Chris Cobb
Shelly Cole
Brandon Cornaby
Heather Cornett
Russell Cotten



Cindy Corteville
Maribeth Crain
DeAnn Crouch
Mendy Davenport
Jeff Dix



Stacey Dinwiddie
Derek Dummermuth
Jennifer Duncan
Donnie Edgar
Stacy Edgar



Jay Euloe
Tanya Farley
Holly Forster
Misha Gensert
Jamie Golden

Patty Oriswald
 Aaron Gum
 Terry Hall
 Dayton Hammond
 Stacie Hammond



Shawn Hardgrove
 Joe Hartwick
 Galen Hayes
 Robert Haynes
 Chris Hess



Nicole Hanley
 Brian Hibdon
 Sheri Hicks
 Lucia Jones
 Masahiro Kawanichi



Nick Kempton
 Kelly Kinney
 Darrell Kreiling
 Jerad Langley
 Angie Lee



Juniors, Nicole Adams and Brandon Cornaby, have fun talking to sophomores in cafeteria study hall.





Going On, Here We Go

1989-90 Junior Class officers are;
 President, Jennifer Duncan,
 Vice-President, Aaron Gumm,
 Secretary, Sasha Scott, and Treas-
 urer Shelly Cole.



Missy Lupardus
 Jason Martin
 Jennifer Matrow
 Paul McDaniel
 Steven McDonald



Julie Medlock
 Kari Miller
 Terry Mosgan
 Angie Morris
 Ray Meyers



Janice Meyers
 Jamie Nath
 Todd Opie
 Shelly Pfantz
 Lisa Pope



Shannon Potter
 Stacey Rader
 Michael Ratcliff
 Jenny Roark
 Brian Rogers

Duane Rush
Margaret Saling
Sasha Scott
Kelly Scurlock
Jenny Schmitz



John Skouby
Cory Stark
Chris Stevens
Mike Stevens
David Tinkler



Rebecca Wall
Jess Webb
Clayton Wells
Candy Williams
Angel Witt



Darin Witt
Joey Wolfe
Shawn Wood
Richard Wright
Nicki Zordel



Kim Zupancic



"Even though there was not a lot of help, all the hard work finally paid off in the end for those who were willing and determined to make prom '90 a success. We felt everyone had a good time and enjoyed everything except for the food," stated Junior class President, Jennifer Duncan.



"We worked late some nights and we hope the seniors appreciated our efforts, because we'll appreciate the juniors' next year. It was also a night I'm sure we'll all remember," commented Darin Bond.

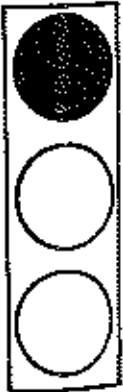
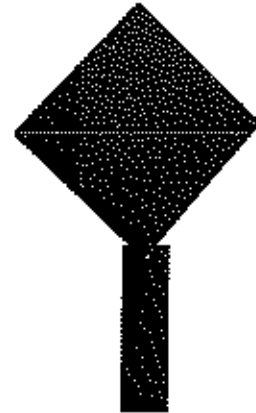

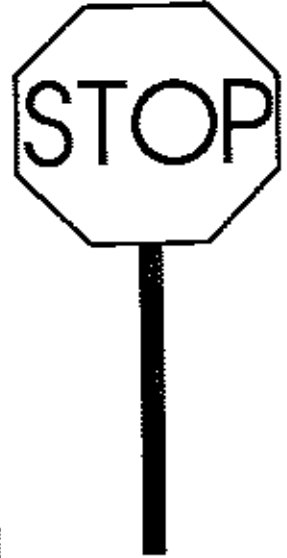
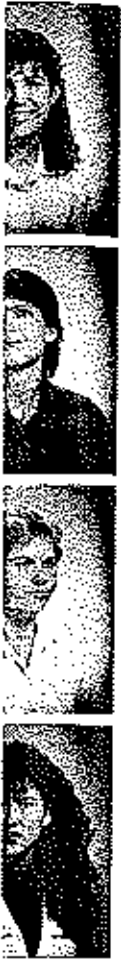

Juniors work hard on prom, but show they can have fun doing it.



Juniors shown are, Darin Bond, Sasha Scott, Jamie Golden, Shelly Cole, Jenifer Duncan, Brandon Cornaby, Aaron Gum, Shawn Wood, Angie Morris, Shelly Phantz, and Chris Cobb. The Juniors worked the Friday night before and the morning of Prom, May 5. The decorations were all done and it was time for the juniors to go home and get ready for the night they will all remember. The Juniors had given the seniors a night to remember.



AnJanette Adkison
Mark Amsinger
Cindy Atteberry
Darin Banner



Paula Bonn
Terry Bishop
Christine Blanchette
Shelie Blomberg



Chris Brandt
Scott Branstetter
Lisa Breshears
Sara Carrender



Is It Really \$Worth\$ It?

Money is an important issue for seniors. Everyone wants as many moments of their last year in high school as possible, but these little keepsakes cost big bucks.

The first thing to buy (or the last for slower people) is senior pictures. The setting can cost anywhere between

\$10 to \$40. Then the actual pictures will be anywhere from \$100 to \$300.

Next come the announcements. Along with those are memory books, tassels, senior keys, plus lots more. The most important part of the purchase is the cap and gown. Prices here

vary between \$50 and \$150. Along with all of this is also a \$25 year-book.

Another must is a senior shirt. It displays the proud year of graduation and the name of everyone in the class. This costs \$9 for a t-shirt and \$16 for a sweat shirt. That means \$25 for



Seniors Darin Banner, Mike Garratt, and Jeremy Frye unusually dressed, do a skit.

Brad Cato
Byron Cato
Scott Christian
Tonya Christian





Jeff Counts
Craig Cox
Tyros Gzeshin
Daria Davenport



Kim Davis
Christine Dolly
Kristi Dennis
Rachelie Duncan



Kirk Earleywine
Chris Eisher
Scott Fillerman
Lisa Everhart



Senior, Mike Frye un-
to a skirt.



those who want both.
One of the largest expenses of all is prom. Since this is the last one, the seniors tend to go all out. The guys have to rent a tuxedo and buy a corsage, and the girls need a formal, accessories, a hairstyle, and a bouffant. On top of all this, there are costs for transportation, after prom, and lots of film. The least amount spent

is around \$150, and from there it can go all the way to \$450. Everything added together, all of these memories can cost anywhere between \$800 to an unbelievable \$1000! Of course, that's just the start. After this they go on to bigger, better, more expensive things.

What was your biggest expense of being a Senior?



"I think the biggest expense was getting my dress and everything for prom and also buying the hundreds of senior pictures to pass out to many of my friends - Jessica Oswald"

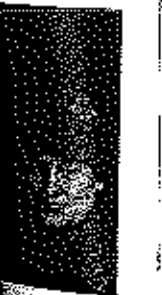

Stacey Fair
Randy Feltaer
Geoff Fish
Jeremy Frye

Mike Garrett
Robert Gibson
Richie Golden
Angela Green



What kind of classes did you take during this year?

Seniors Take Time and Effort

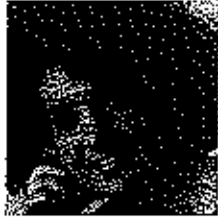

"My classes weren't as hard this year as my Junior year, but they were demanding, especially Drama and Debats."
-Shannon Sohekorra

The senior year can go one of two ways. Either extremely hard or with total and complete ease. Some students this year took every academic class possible. These include World Literature, Research, Analytics, and Physics. Any one taking all of those

classes ends up with constant homework and tests all year. The good part is that these people are more prepared to take college courses next year. Others take a bit of a lighter load. There are a few seniors with as many as three study halls. Oth-

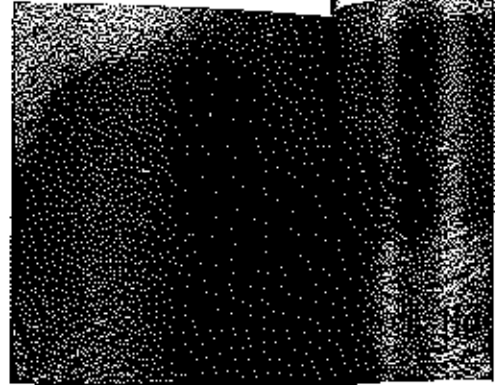

Seniors Darl and Lisa from Drama Club

Stacie Hager
Mike Halderman
Greg Hand
Mike Hawken



Amanda Hedden
Jason Hees
James Hendricks
Lynne Heuloy



Jeffrey Hoffman
Robert Holder
Jonathan Howser
Sharon Hull





Kierstan Jones
 Danny Kliehermes
 Robert Koop
 Mike Langston

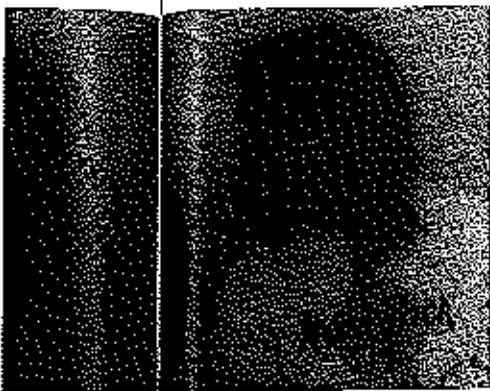

Seniors Darla Davenport and Lisa Breshears talk during Drama Class.

er classes requiring less academic work are P. E., choir, band, and drama. Even though these subjects take up plenty of class time, they leave nearly all of the out-of-school time free to work or party.

As the end of the year came closer, everyone began to get antsy about getting out. A classic case of senioritis. All of

the seniors started having trouble concentrating on books, no matter whether their classes were easy or hard. Fortunately, final tests and assignments were turned in and everything was finished in enough time to have a wonderful 1990 graduation.

What kind of classes did you take during your Senior year?



"I took hard classes and I hated every minute of it, but it will be worth it next year"

-Jenny Kessel

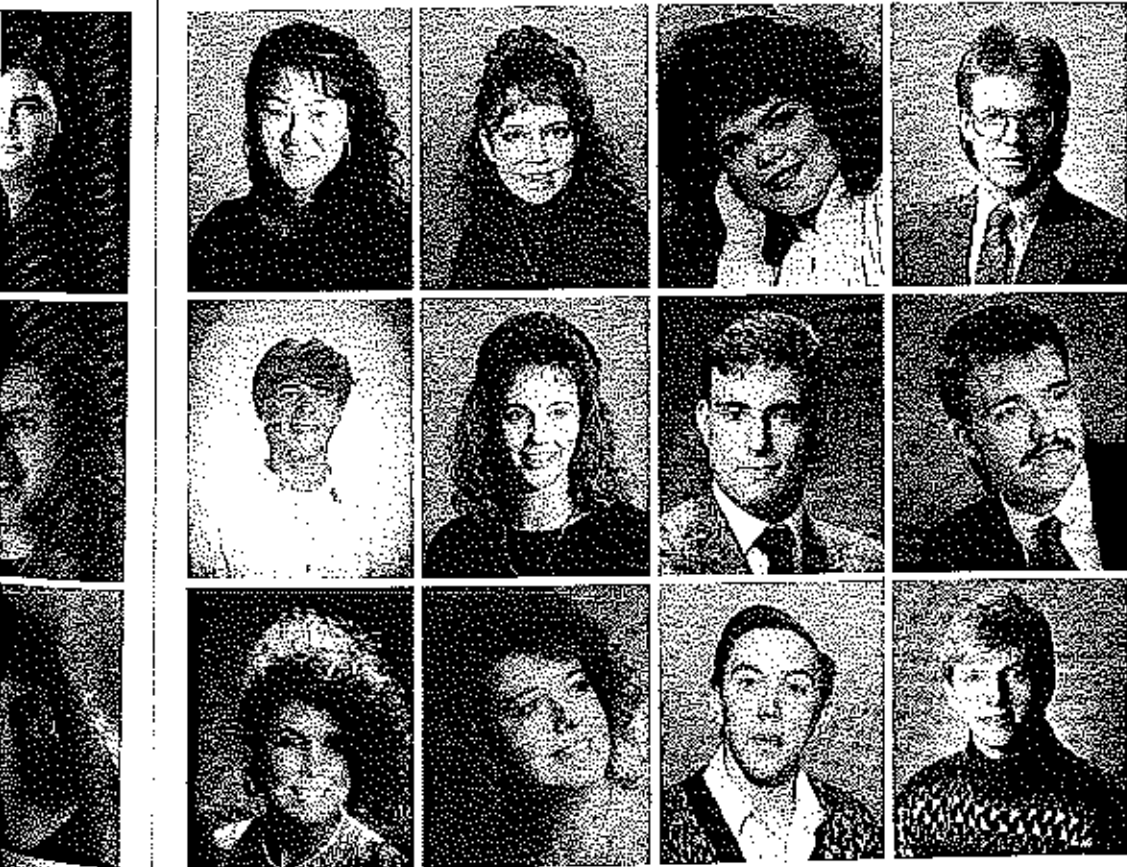

Karina Larson
 Karen Lee
 Melissa Jeffert
 Scott Little

Kyle Macfadyen
 Kim Marriott
 Joe Martin
 Jason McGhay

Dixie Miles
 Christi Miller
 James Mims
 Wade Misteveich

Roger Mitchell
Mike Morgan
Anthony Opie
Jessica Oswald



Donald Overton
Brad Owings
Chris Parr
Sean Petet



Taking A Look At The Wonder Years

1990's senior class has come a long way. Most of them have been going to school together for the past thirteen years. During this time, many close, bonding friendships have developed.

It all started with kindergarten. Everyone entered that year as indi-

viduals, but ended it as a class. Things such as reading, writing, and arithmetic were learned in elementary school, but that's not what makes the memories. More of them could be made in one recess than in an entire week of classes. Activities like kickball, hopscotch,

tetherball, and jump rope were the excitement of the day.

Junior high school seemed like a big step. That's when the students changed buildings, had a different teacher for every class, and got a locker. During these years they had to dissect their first

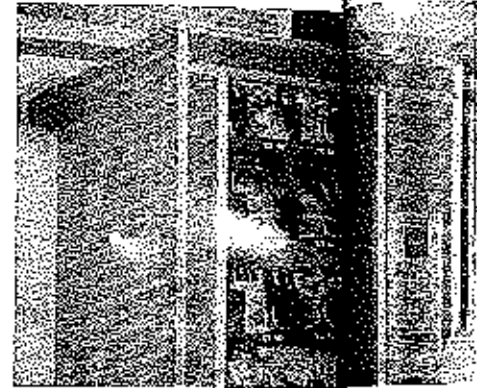

Senior James Mims makes his selection at the candy machine.

Angela Procter
Carla Purdom
Travis Rader
Jenny Rossal



Melissa Hourk
Kevin Robinett
Deanna Rogers
Larry Salsman



SENIORS' THE CLASS OF 1990

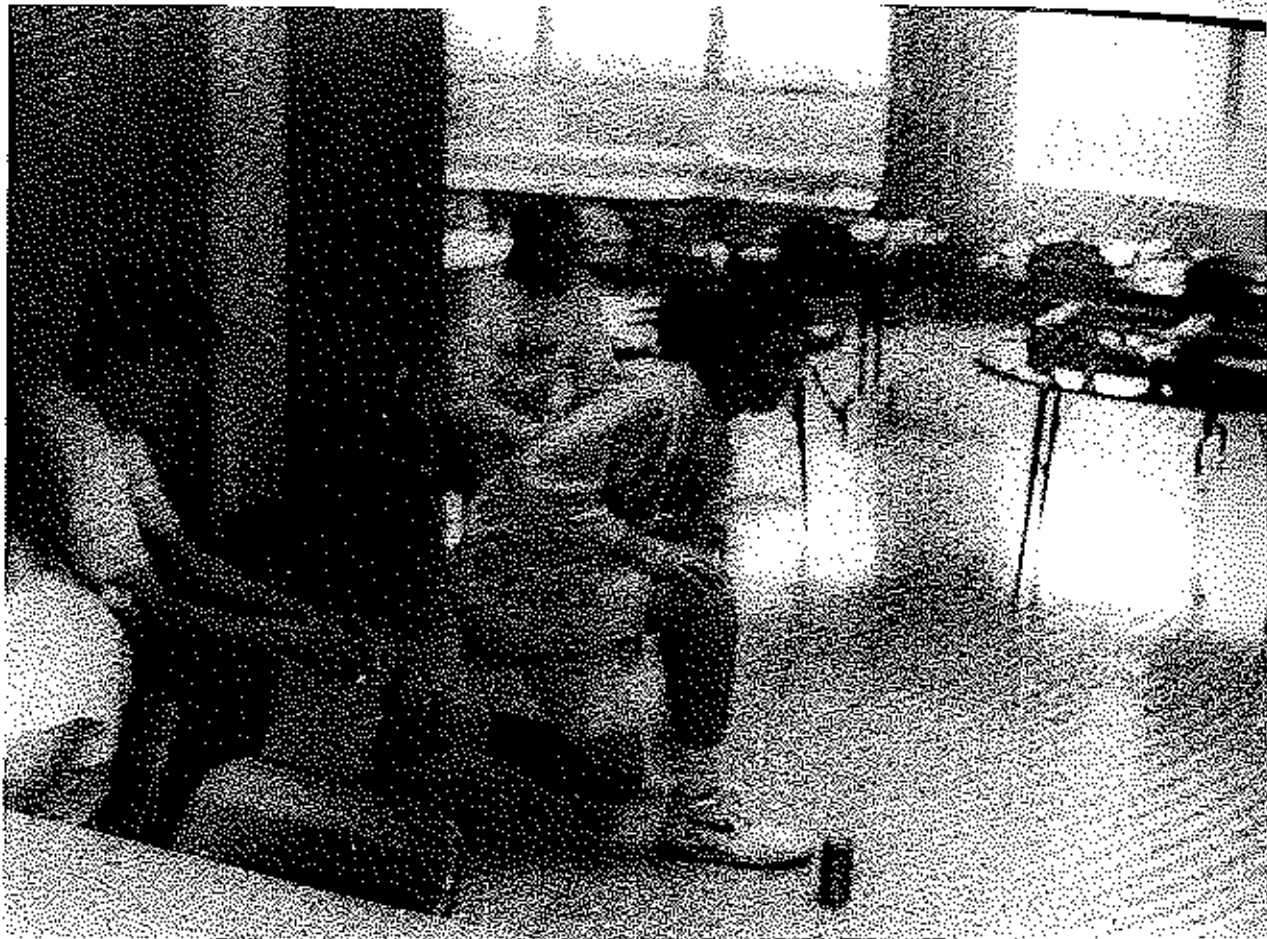

OPPOSITE PAGE
Farr keep study hall
Freedom and Joel V
Missouri, bottom: ri
spies for the photo
Megan shows hot
Schokoffa, above l
for the camera after
in study hall in ph
the way to action!





OPPOSITE PAGE - top - Roger Mitchell, Brad Owings, Chris Fack keep study hall interesting with games. bottom left - Carla Furdom and Josi Vaughan enjoy a pizza at Plaza Hut in Eldon, Missouri, bottom right - Jeremy Frys models the senior class T-shirt for the photographer. THIS PAGE - above - Junior, Terry Morgan shows how much strength he has to senior, Shannon Schukoren, above left - Stacie Hager and Scott Ellerman smile for the camera after a football game. below - the senior attraction in study hall is playing a variety of games to board games all the way to action as seen here.

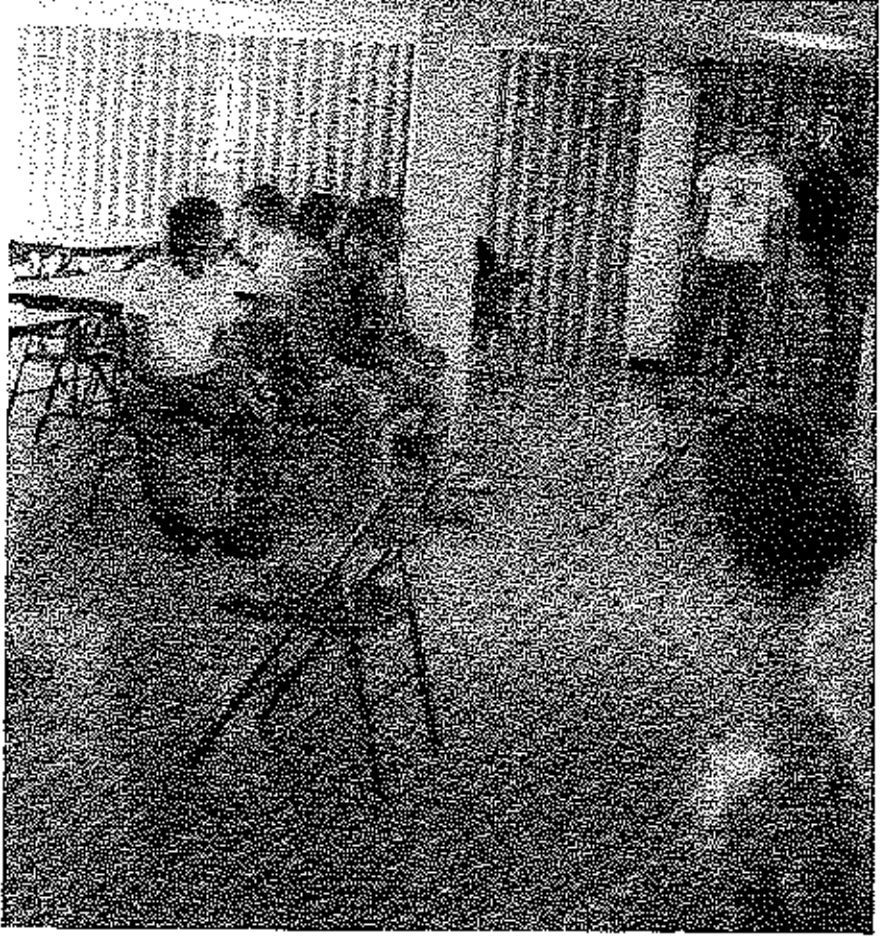

THE FUTURE BEGINS HERE

The Eldon High School ended with the graduating of the senior class of 1990.

The class has grown together as friends and foes, but through it all they have made it to the top of secondary education.

With your senior year comes challenges with being accepted to college of your choice, starting a family, or joining the armed forces. This is first major decision for

the rest of their life.

The competition for the top twelve places for the senior class is a trial facing many seniors this year. It ended with Valedictorian, Robert Gibson; Salutatorian, Cindy Atteberry. The Top Ten are: Cindy Atteberry, Ty Czeschin, Robert Gibson, Angela Green, Mike Hawken, Jeff Hoffman, Jessica Oswald, Jenny Ressel, and Deanna Rogers.



ABOVE - Valedictorian, Robert Gibson receives diploma from Eldon Schools superintendent Walter Mooney. RIGHT - Seniors: Robert Gibson, Todd Spriggs, Scott Braastetter, Jeff Hoffman, and James Upton are getting ready to walk to their seats. BELOW - A senior accepts his diploma for Walter Mooney and Jim Wilson while on lockers watch.



C
- Cin
Larry
on H
I
ENC
stett
f
Shav
C
Ang
f
SHI
ers.
Mar
:
SHI
- Sa
SCH
Dea
Scot
SCH
HE
SHI
MI
SCI
Car
SCI
SCI
ED
LA
SCI
son
LE
La
EN
sof
VE
CO
AV
Cz
Gr
Re

O. G. JAMES MEMORIAL SCHOLARSHIP - Cindy Atteberry, Jeff Hoffman, Karen Lee, Larry Salsman, alternates - Mike Garrett, Sharon Hull, Kim Marriott.

MERCANTILE BANK OF ELDON SCIENCE AWARD - Cindy Atteberry, Scott Branstetter, Robert Gibson.

SHIELD OF SHELTER SCHOLARSHIP - Shawn Spalding.

OPIES' MILKHAULERS SCHOLARSHIP - Angela Green.

CITIZENS BANK OF ELDON SCHOLARSHIP - Shawn Spalding alternate - Deanna Rogers.

G. W. SMITH SCHOLARSHIP - Kim Marriott, Alternate - Mike Morgan.

M.F.A. SCHOLARSHIP - Sara Carrender.

KNIGHTS OF COLUMBUS SCHOLARSHIP - Mark Amsinger.

ELDON CTA TEACHERS SCHOLARSHIP - Sara Carrender, alternate - Bradley Owings.

BRADLEY GRISWOLD MEMORIAL SCHOLARSHIP - Michael Morgan.

FRIENDS OF MUSIC SCHOLARSHIP - Deanna Rogers.

CLAXTON MEMORIAL SCHOLARSHIP - Scott Ellerman, alternate - Jeremy Frye.

GREATER LAKE AREA ARTS COUNCIL SCHOLARSHIP - Larry Salsman.

ELDON SKELLED CARE CENTER HEALTH SCHOLARSHIP - Michael Langston.

GERALDINE HALDIMAN SCHOLARSHIP - Angela Procter, alternate - Christie Miller.

JOE U. DAVENPORT MEMORIAL SCHOLARSHIP - Scott Branstetter, Sara Carrender, Jeff Hoffman, Shawn Spalding.

MISSOURI TEACHER EDUCATION SCHOLARSHIP - Brad Owings.

UNIVERSITY OF MISSOURI ALUMNI SCHOLARSHIP - Jeff Hoffman.

MISSOURI DEPARTMENT OF HIGHER EDUCATION BRIGHT FLIGHT SCHOLARSHIP - Robert Gibson.

ARMY ROTC SCHOLARSHIP - Dale Smith.

UNIVERSITY OF MISSOURI CURATORS SCHOLARSHIP - Cindy Atteberry, Robert Gibson.

UNIVERSITY OF MISSOURI EXCELLENCE AWARD - Mike Hawken, Jenny Ressel, Larry Salsman.

UNIVERSITY OF MISSOURI COLUMBIA-ENGINEERING - Cindy Atteberry, Robert Gibson.

SOUTHWEST MISSOURI STATE UNIVERSITY PRESIDENTS LEADERSHIP COUNCIL - Jessica Oswald.

GEORGE WASHINGTON CARVER AWARD - Mark Amsinger, Cindy Atteberry, Ty Czeschin, Mike Garrett, Robert Gibson, Angela Green, Jeff Hoffman, Jessica Oswald, Jenny Ressel, Deanna Rogers, Larry Salsman.

NORTHEAST MISSOURI STATE UNI-

VERSITY-KIRKSVILLE-

PRESIDENTS HONORARY SCHOLARSHIP - Scott Branstetter, Todd Spriggs.

PRESIDENTS COMBINED ABILITY - Angela Green.

GOVERNORS - Scott Branstetter, Todd Spriggs.

CENTRAL MISSOURI STATE UNIVERSITY SCHOLARSHIP-WARENSBURG-

REGENTS - Scott Branstetter.

PRESIDENTS AWARD - Sara Carrender, Shawn Spalding.

UNIVERSITY SCHOLAR - Ty Czeschin.

ACHIEVEMENT AWARD - Ty Czeschin.

RECOGNITION - Carla Purdom.

LINCOLN UNIVERSITY DEANS SCHOLARSHIP - Mark Scrivner.

SOUTHWEST BAPTIST UNIVERSITY-BOLIVAR - Darin Banner.

U.S. MARINE CORPS FOUNDATION SCHOLARSHIP - Mark Amsinger.

MARY AND LEO MARTIN LOVE SCHOLARSHIP - Darin Banner.

STEPHENS COLLEGE AND TWYMAN MEMORIAL SCHOLARSHIP - Shellie Blomberg.

CENTRAL METHODIST COLLEGE SCHOLARSHIP - Deanna Rogers.

UNIVERSITY OF MISSOURI VOLLEYBALL SCHOLARSHIP - Melinda Wrye.

UNIVERSITY OF MISSOURI GYMNAS-TIC SCHOLARSHIP - Kim Marriott.

NATIONAL MERIT COMMENDED STUDENT - Robert Gibson.

DISTRICT ATHLETE AWARD - Jessica Oswald.

DISTRICT MUSIC AWARD - Chris Parr.

SCHOLAR/ATHLETE AWARD - Cindy Atteberry, Michael Gerrett.

EUTERPEAN ENGLISH AWARD - Robert Gibson.

DAR CITIZENSHIP AWARD - Cindy Atteberry.

AMERICAN LEGION GOD AND COUNTRY AWARD - Darin Banner, Sara Carrender.

ELDON KIWANIS SERVICE AWARD - Sara Carrender.

COLLEGE PREPARATORY CERTIFICATE - Mark Amsinger, Cindy Atteberry, Scott Branstetter, Ty Czeschin, Mike Garrett, Robert Gibson, Sharon Hull, Brad Owings, Jenny Ressel.

PRESIDENTS ACADEMIC FITNESS AWARD - Mark Amsinger, Cindy Atteberry, Shellie Blomberg, Ty Czeschin, Mike Garrett, Robert Gibson, Angela Green, Mike Hawken, Jeff Hoffman, Sharon Hull, Karen Lee, Jessica Oswald, Jenny Ressel, Larry Salsman, Todd Spriggs.

1, Robert
na from
student
(T - Sen-
1, Todd
ster, Jeff
pton are
to their
nior ac-
Walter
on while

I'll Rememper



Preparing the gym for prom, juniors Brandon Cornaby, Stacey Rader, Darin Bond, Holly Forester, and Shelly Cole, decorate the night before. Carla Purdom and Charlie Tompkins pose for a picture before prom. Steven McDonald and Holly Forester enjoy the meal while April Ballinger comes to take a picture.



The Price Of Prom

Prom is a memorable experience for everyone. It can also be very expensive. With all the elegance and beauty, there is a price tag to match it. Money is raised by the Junior class throughout the year to pay for the prom. They sold refreshments at football and basketball games. The money raised went toward many different things. Prom planners bought everything from napkins to the entertainment.

When the
taled it w
mately \$31
While th
was paid fo
ior class, th
many per
ses. Dresse
\$100 to \$
cost abou
were from
You can'
"custom"
will cost yo
Tuxedos
either, ec
\$75.
Pg. 58.

member You . . .

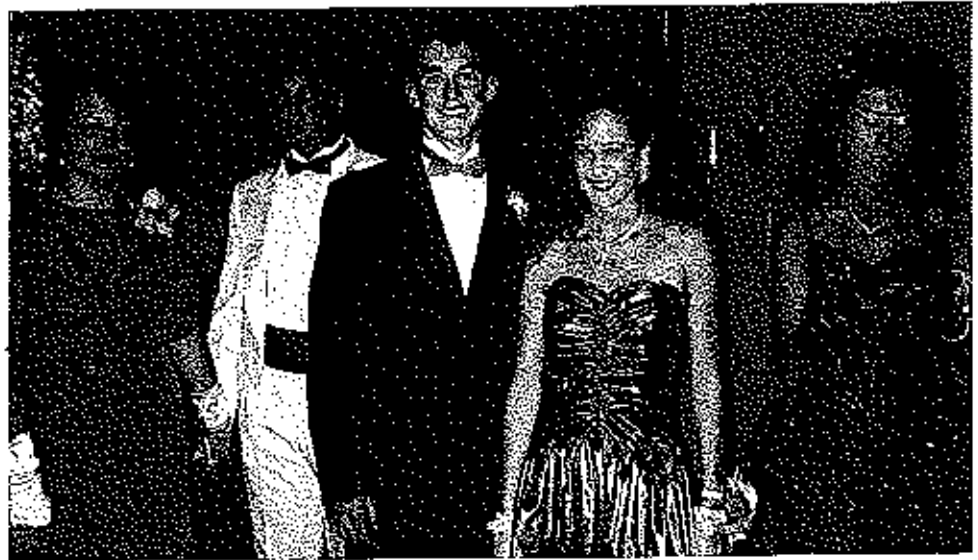

Walking into prom seems to be a group effort for Seniors, Mike Hawken and Jeremy Frye, and Juniors, Stacey Hammond and Sasha Scott, and Sophomore Marcia Milburn. When the final event came many only a few seats were empty. Nickie Zordel, David Abbott, Dawn Bond, and Donnie Edgar, sat and enjoyed being served by the eighth grade girls.

re Of Prom 1990

memorable
r every-
be very
hall the
beauty,
e tag to
ney is
Junior
out the
or the
old re-
football
games.
ed went
fferent
anners
thing
the en-

When the bill was totaled it was approximately \$3100.00.

While the actual prom was paid for by the Junior class, there were still many personal expenses. Dresses ranged from \$100 to \$600. Jewelry cost about \$50. Shoes were from \$20 to \$40. You can't forget the "custom" hairdo, which will cost you around \$20. Tuxedos aren't cheap either, costing \$50 to \$75. . . . continued on pg. 58.



Expensive; But Worth It!

"After Prom" seems almost as important as the prom itself. Many students rent condominiums that range around \$150. This is without food and entertainment. For your party snacks and beverages it will cost \$25.

You can't forget that entertainment (renting movies or buying tapes for the stereo) that will cost about \$15.

When the bill is totaled, We find out that for about \$1025.00 you, too, can have a good time on prom night.



Crowned the 1990 Prom queen and king, Mike Morgan and Stacey Fair, except the crown and scepter with host of amies. Darin Bond and Jolene Van Hooser leave, headed for prom, with the hopes of a fun evening ahead. Bo Claridge rides a barrel as part of some "after prom" fun.

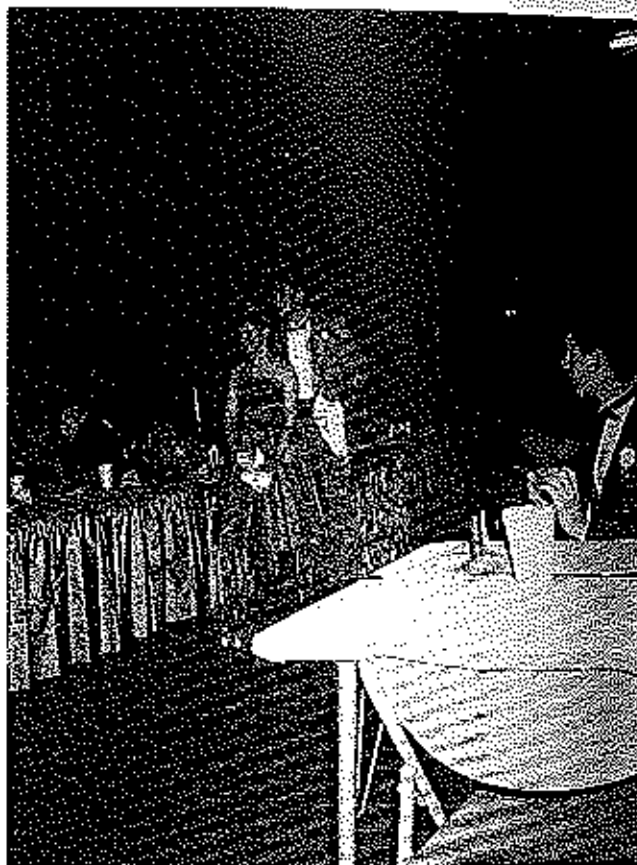

It!

ORGANIZATIONS



EHS

Eldon High School offers a wide variety of organizations to students. They range from Future Farmers of America to SLASH, a peer counseling group.

WHERE DO WE GO
FROM HERE?!

-Eldon Marching Mustangs Gain Top Awards-

The second parade attended was the CMSU Homecoming parade they received a second place trophy, losing first by one point from Warrensburg High School. The last parade attended by the Mustangs was the Jefferson City Christmas parade which they received third place trophy. The Marching Mustangs was led this year by Drum Majors Chris Parr and Jeff Hoffman. They received the Drum Major award at the SMSU parade. The Flag Corps co-captians are Sara Carrender and

Sharon Hull.

The Eldon Marching Mustangs had a busy semester. They led off with the fall homecoming. They performed in the homecoming parade and with a field show at the football game that night.

They participated in three parades during their season. The first parade was the SMSU Homecoming parade and was awarded with the second place trophy. The second parade attended was the CMSU Homecoming parade they received a second place trophy.



Eldon Marching Mustangs march one last time.

The Eldon Marching Mustangs march down Main Street in Eldon, Missouri at the Fall Homecoming parade.

The Marching Mustangs perform a field show of entertainment to "Rock Around the Clock" and "Veracruze". At one of the home football games.

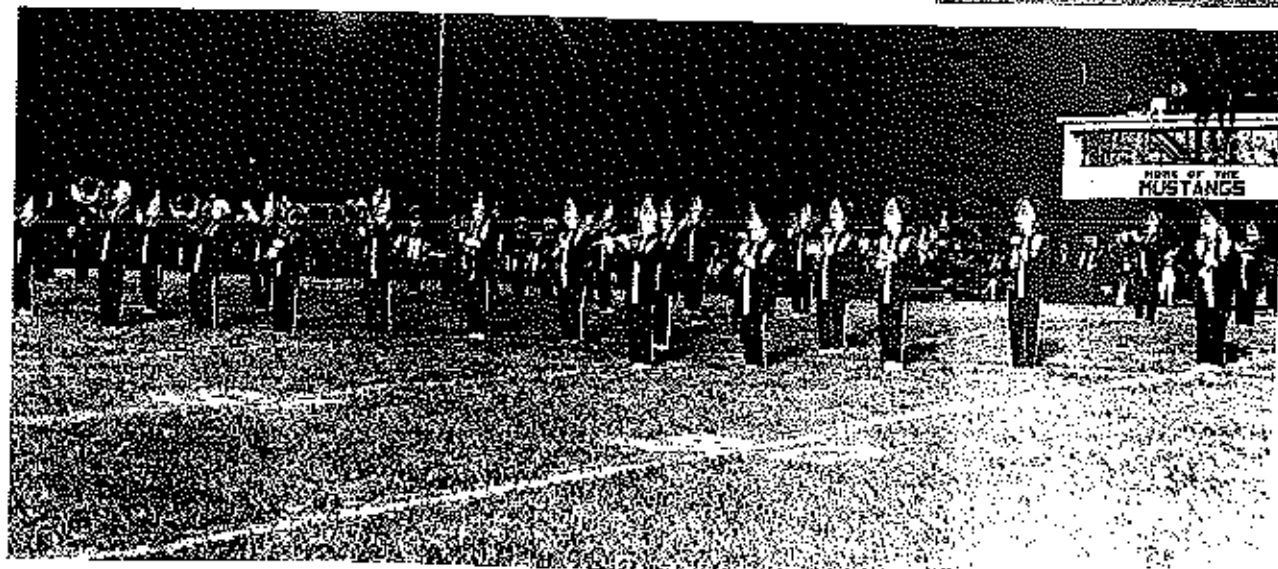
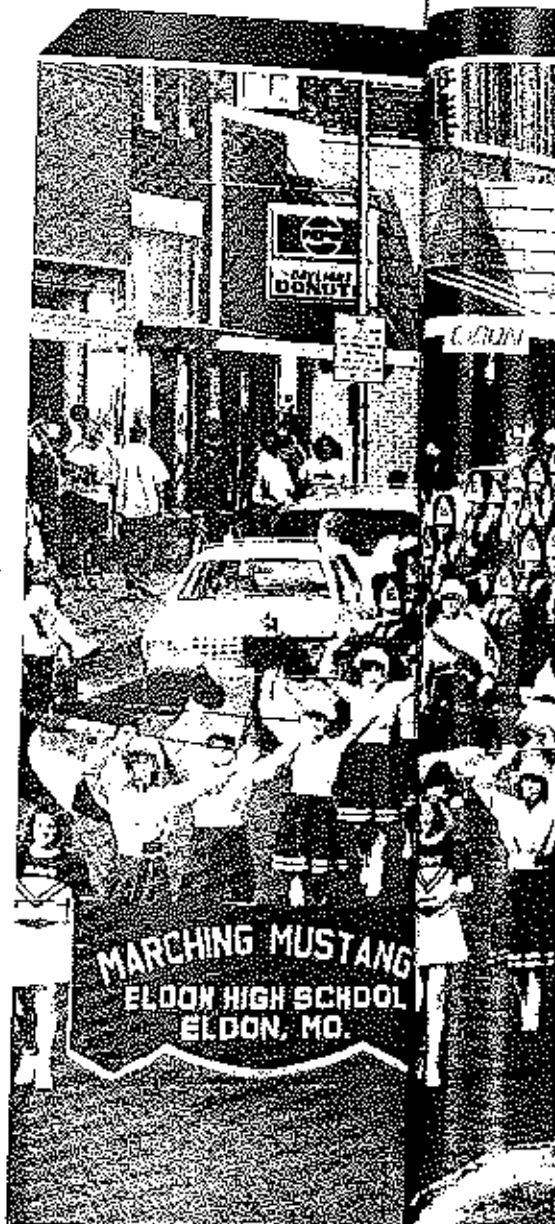
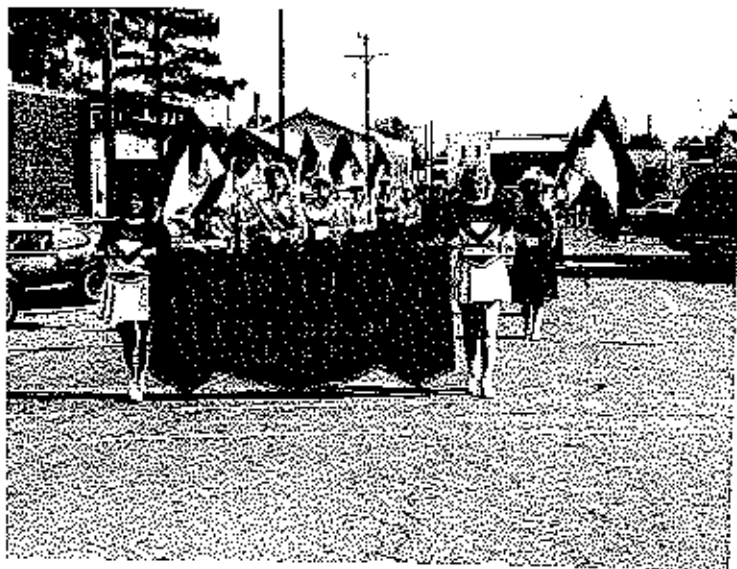

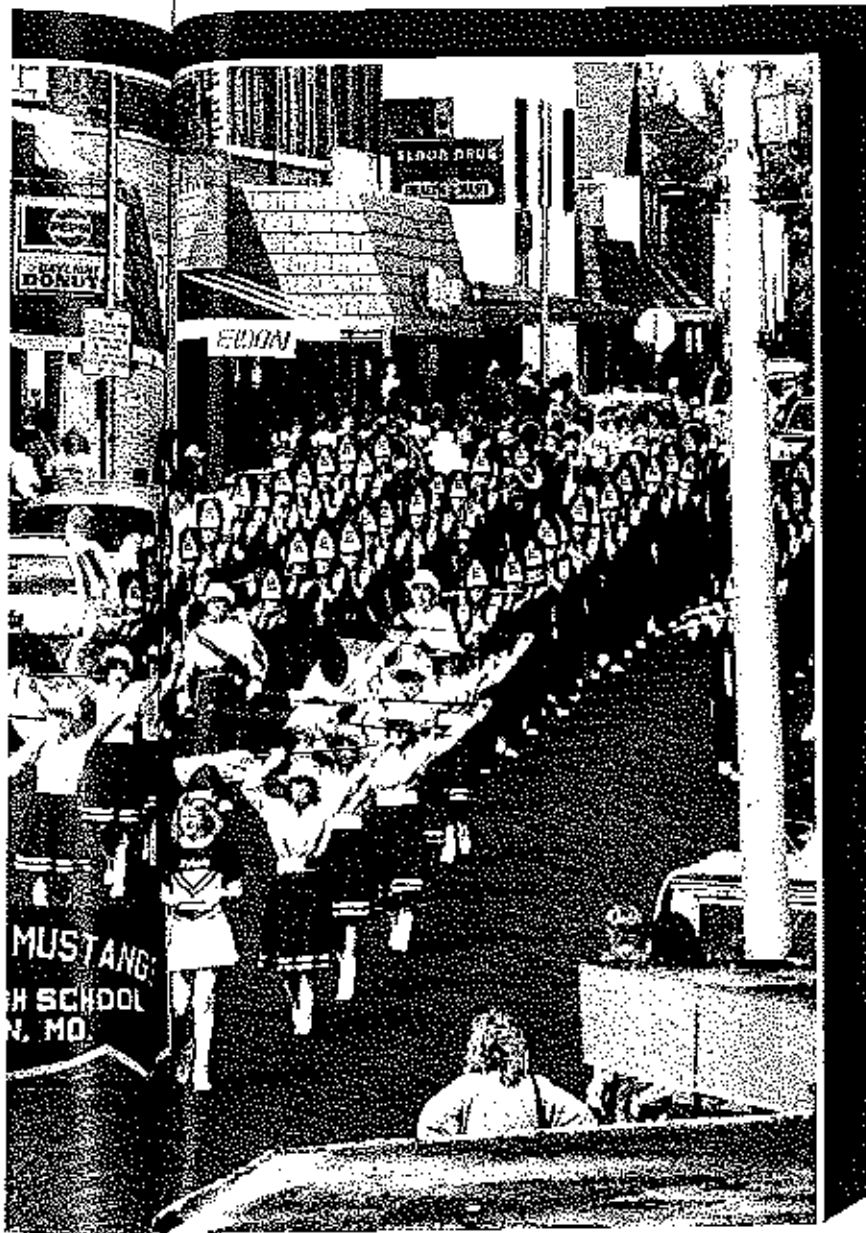

Junior Melissa Bax waits for performance time at the Eldon 1989-1990 Graduation ceremony.

Eldon Marching Mustangs march around a corner, finalizing the end of the Homecoming parades.



Band earns high honors

The Christmas concert was the first performance on the agenda. Then comes the Chili supper the fundraising activity. The money made was for the new marching band uniforms. After Chili Supper the concert band and individuals start learning music for "Grade A" performance. With this

they performed at Tri-County Music Festival, District Music Contest at Jefferson City and State Music Contest at Columbia. The Eldon Concert Band received a I at District and State Contest. The Concert band had a year of many events but it did not seem to overcome the members of the Eldon

Marching and/or Concert Band.

The Eldon Concert Band kept busy this year with their annual activities. They started right off with a change from marching to concert style. With this change comes a new style of music, different uniforms, and no early morning band practice.

Concert Band 61



Music students perform

This year the stage band participated at many of the home basketball games. They play a wide variety of music ranging from modern rock to jazz.

The crowd seemed to enjoy the half-time entertainment. Stage band will continue their performance during the basketball season, along with going to contests during the year.

Stage Band warms up before a home basketball game.



Under the direction of Rex McCarger, the Stage Band entertains during the Queen of Popularity and Beauty contest at Basketball Homecoming.





Top, left: Members of the Mixed 8 choral group receive awards from choral director Carrie Burchett. Below: Girls choir members perform during the Spring concert and awards assembly.



Mixed 8 receives awards

Sophomore Kellye Crockett presents the choir's gift to Ms. Burchett at the honors assembly.

NEW ORGANIZATIONS

Future Teachers of America is the only organization in Missouri for high school students who are interested in a career in teaching. Eldon's chapter debuted this year with Mrs. Connie Wyrick as the sponsor. The organization had approximately twenty members. They participated in the homecoming parade, attended State Leadership Conference, and observed teachers at the Elementary School. Some volunteer juniors and seniors helped tutor elementary students. The 1989-1990 officers included Lisa Pope, president; Christy Barr, vice-president; Jenny Schmitz, secretary; Jennifer Matrow, treasurer; and Misha Ginsert, reporter.



First row, Jenny Schmitz, Misha Ginsert, Mindy Davenport, Lisa Pope, Christy Barr, and Jennifer Matrow. Second row, Lori Christner, Erica Gee, Molly Wirtz, Stacie Hammond, Brad Griggs, and Leah Twyman. Third row, Kelly Schubert, Felicia Van Housar, Joy Williams, Sus Myers, Lois Light, and Rancee Pope. Fourth row, Sara Carrender, Beth McKinley, Dana Davis, Roger Mitchell, and Heather Hayes.

Fellowship of Christian Athletes was organized for athletes and coaches to present the challenge and adventure of receiving Jesus Christ as Savior and Lord. They participated in the Homecoming parade, influenced others with bead bracelets, met for breakfasts on mornings before school, and had various activities throughout the year. There were approximately 25 members with Coach Todd Shockley as sponsor. The 1989-90 officers included Jeremy Frye, pres., Darin Banner, vice-pres., Jessica Oswald, sec., Sara Carrender, tres., and Galen Hayes, membership chairman.



Seated: Connie McDewitt, Jennifer Lovelace, Amy Webster, Shawn Wood, Advisor, Todd Shockley, Mike Garrett, Sara Carrender, and Gladys Astberry. Standing: Dana Davis, Beth McKinley, Jessica Oswald, Chris Newton, Scott Ellerman, Galen Hayes, Darin Banner, Steve Henderson, Jason Baker, and Jeremy Frye.

NS

Show-Choir Excels

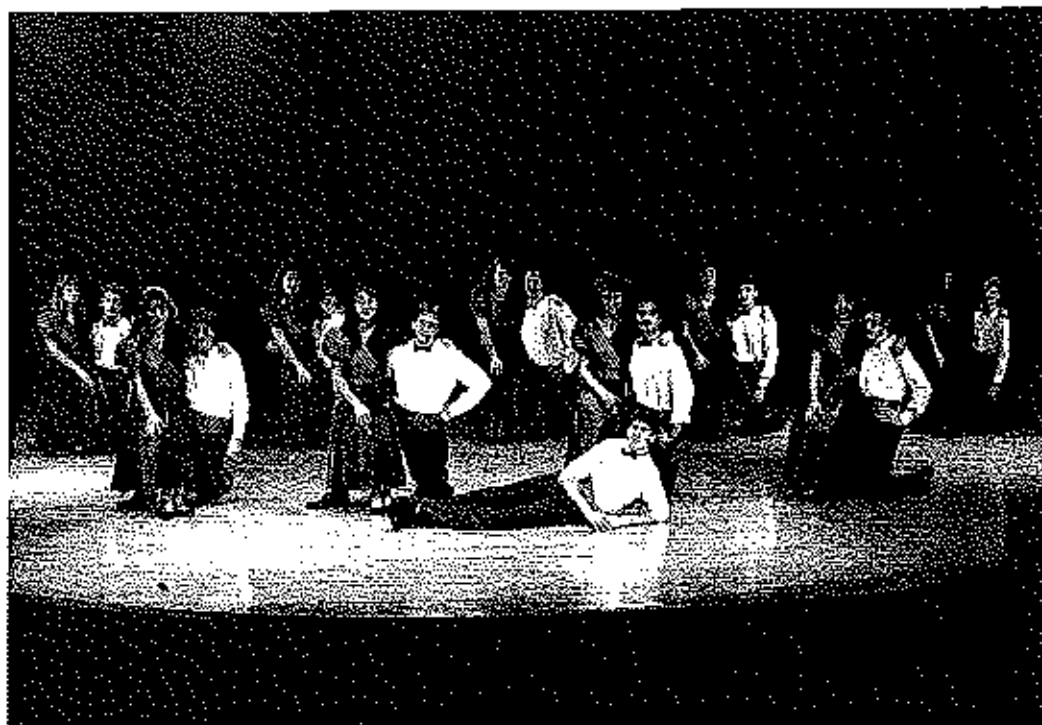

Show-Choir members are, Carol Martin, Darin Bond, Heather Hayes, Jason Baker, Deanne Rogers, Josh Harvey, Kavina Larson, Jeff Hoffman, Stacey Hammond, Duane Rush, Angela Proctor, Dale Smith, Leah Twyman, Chris Newton, Kellye Crockett, Brian Burns, Jennifer Matrow, and Doug Portor. Laying down; Chris Parr.

Second row: Left
port, Jelone Van-
na Davis, Roger



Sara Garrou-
Jalen Hayes,



This year Eldon High School was fortunate enough to have three foreign exchange students. Karina Larsen is from Denmark and she lived with the Ed Schler family. Kyle MacFadyen is from Scotland and he lived with the Danny Bond family. Masahiro Kawanishi is from Japan and he lived with the Don Garrett family. Kyle and Karina are seniors and Masahiro is a junior.

The group participated in many events this year in honor of Karina, Kyle,

and Masahiro. They had a overnight lock in at the high school gym, they had their annual Thanksgiving dinner, they also had a Christmas dinner. They went roller skating and at the end of the year they went miniature golfing and rode go-carts.

The 1989-90 AFS chapter officers elected for the year were: president, Cindy Corteville, vice-president, Deanna Rogers, and secretary, Connie McDevitt.

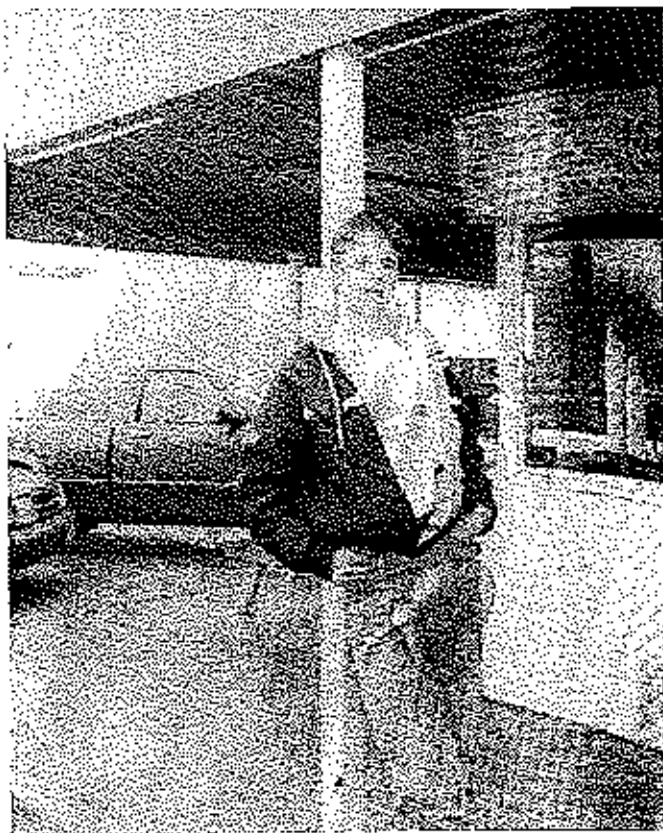

Kyle MacFadyen, senior AFS student from Scotland, hangs out at Cree Mees after a hard day at school.



Front Row: Sandra Ingram, advisor, Cindy Corteville, Masahiro Kawanishi, Karina Larsen, Kyle MacFadyen, Deanna Rogers, Connie McDevitt Second Row: Maria Kempker, Joy Williams, Sue Myers, Beverly Witt, Karen Lee, Jason McGhay, Jennifer Duncan, Tyrus Czascchin, Amanda Hedden Third Row: Stacie Hammond, Mandy Webery, Angela Skouby, Robin Hutcherson, Julie Medlock, Michael Lee, Kimberly Green, Kellye Crockett, Melissa Bax, Jennifer Porter Fourth Row: Tim Bradley, Shawn Spalding, Randy Feltner, Jeff Hoffman, Angela Green, Shelly Cole, Jenny Bessel, Sharon Hull, Jason Baker Back Row: Amy Howell, Denise Reed, Mike Langston



Masahiro Kawanishi, junior, poses for a picture in P. E. This was one of his elective courses for his year here.

SLASH
tending a
Helping,
during,
school year
organization
students
selected
mates as
people w
can disc
lems.

Stud
through
inars to
counsel
They als
training
school o

On a
student
students
lems. T
provide
health
those v
comfort
a coun
adult.

The
1989-9
were; p
Carrei
preside
naby.



Riding
Attebe
mores,
Jason

SLASH, Students Listening and Students Helping, was organized during the 1985-86 school year. It is an organization consisting of students who have been selected by their classmates and teachers as people with whom they can discuss their problems.

Students went through training seminars to expand their counseling techniques. They also have ongoing training with the high school counselors.

On a daily basis these students helped other students deal with problems. Their goal was to provide students with a healthy network for those who do not feel comfortable talking with a counselor, or any adult.

The officers for the 1989-90 school year were; president, Sara Carrender, and vice-president, Brandon Cornaby.



Front Row: Shannon Schekorra, Deanna Rogers, Brandon Cornaby, Sara Carrender, Cindy Atteberry, Dana Davis Second Row: Kim Zupanoio, Sharon Hull, Connie McDevitt, Holly Forsster, Nicole Henley, Maribeth Crain, Beth McKinley Third Row: Brad Cato, Anthony Opie, Byron Cato, Scott Ellerman, Jeremy Frye, Galen Hayes, Shawn Wood, Cindy Cortevillo, Jason Baker Fourth Row: Lisa Pops, Renee Pope, Craig Atteberry, Jessica Oswald, Melissa Bax, Leah Twyman, Heather Hayes Fifth Row: Larry Salzman, Tim Wood, Scott Spears



and, hangs out



ishi, junior, in P. E. This tive courses



Riding on the SLASH float in the Homecoming parade are Cindy Atteberry, senior, Connie McDevitt, Beth McKinley, sophomores, Jeremy Frye, Tyrus Czeschin, seniors, Maribeth Crain, Jason Baker, juniors

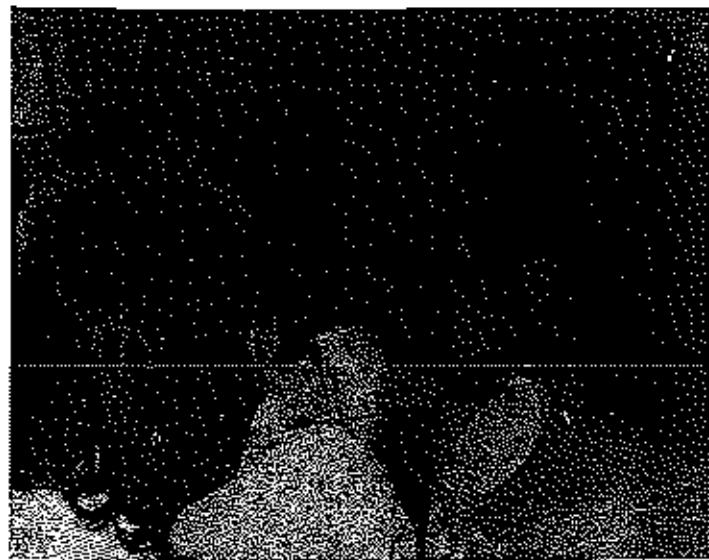

Attending a SLASH seminar are Anthony Opie, Sharon Hull, Scott Ellerman, Jenny Ressel, seniors

STUDENT COUNCIL: Where did they go this year?

Members of the Student Council are an important part of the student body. The Eldon High School Student Council of 1989-90 was one of the most active in recent years. Headed by president, Tyrus Czeschin, vice-president, Cindy Atteberry, treasurer, Sara Carrender, and secretary, Sasha Scott, they did many things to make this year an excellent one for EHS students.

One of the first things the

Council did was introduce both a student and teacher recognition each month. The "big" activity this year was the Haunted House held in the Fine Arts Building Tunnels. Other activities included the Winter Ball Dance in January, Student Council exchange with St. Elizabeth, and both Homecomings.

The Student Council was advised by Chris Spencer and Jim Wilson.

Front Row: Melinda Wrye, Ty Czeschin, Cindy Atteberry, Sara Carrender. Second Row: Brook Czeschin, Cecelia McDewitt, Christie Martin, Sharon Hill, Todd Smith, Kim Macfott, Wendy Davenport, Aaron Dun, Darin Davenport. Third Row: Nicole Jenley, Jennifer Duncan, Sasha Scott, Shelly Cole, Nicole Hammond. Fourth Row: Renee Pope, Mark Brenner, Mike Garrett, Carla Fiedora, Scott Little, Emerson Cornaby, Deanna Rogers, Todd Springs, Kristi Miller.

Seniors, Cindy Atteberry and Deanna Rogers, junior, Sasha Scott and sophomores, Stephanie Leivan relax at StarCo fun night.



1989-90 OFFICERS are Tyrus Czeschin, president; Cindy Atteberry, vice-president; Sara Carrender, treasurer; Sasha Scott, secretary.

The
of Na
ciety
een n
Nov
This
ment
Th
NHS
basia
ship
servic
In o
NHS
main
a 12



Senior Larry Saleman donates blood during the annual Red Cross blood drive sponsored by National Honor Society.



NHS supports service

The 1989-90 edition of National Honor Society inducted eighteen new members on November 6, 1989. This brought the total membership to 39.

The members of NHS are chosen on the basis of their leadership, scholarship, service, and character. In order to stay in NHS, members must maintain a 3.0 gpa on a 12 point scale.

Two major projects occupy NHS members time. The first is the annual blood drive sponsored in cooperation with the local chapter of the American Red Cross. NHS members organize the publicity for the event, provide volunteers for registration and help with other aspects of the process as need be. Members are also encouraged to donate blood if possible.

Members of NHS: first row: Deanna Rogers, Sharon Hull, Sara Carreander, Mike Garrett, Scott Little, Jenny Russell, Jessica Oswald, Christy Barr, Galen Hayes, Beverly Witt, Kara Lea, Mandy Davenport, Kim Marriott, Lisa Pope, Melissa Bax, Angela Procter, Stacie Hammond, Sasha Scott, Angela Green, Cindy Atcherry, Jason Martin, Maribeth Crain, Hero Kamaulchi, Jeff Hoffman, Carla Purdom, Brandon Cornaby, Shelly Cois, Todd Spriggs, Shawn Abbott, Larry Saleman, Jenny Schmitz, Darin Banner, Nicole Henley, Ty Czeschin, Shawn Spalding, Mike Morgan, Robert Gibson, Mark Amsinger, Mike Langston.

The second project is the annual awards assembly held in the Spring to honor academic success. The NHS president serves as master of ceremonies of the event.

FFA; Going P

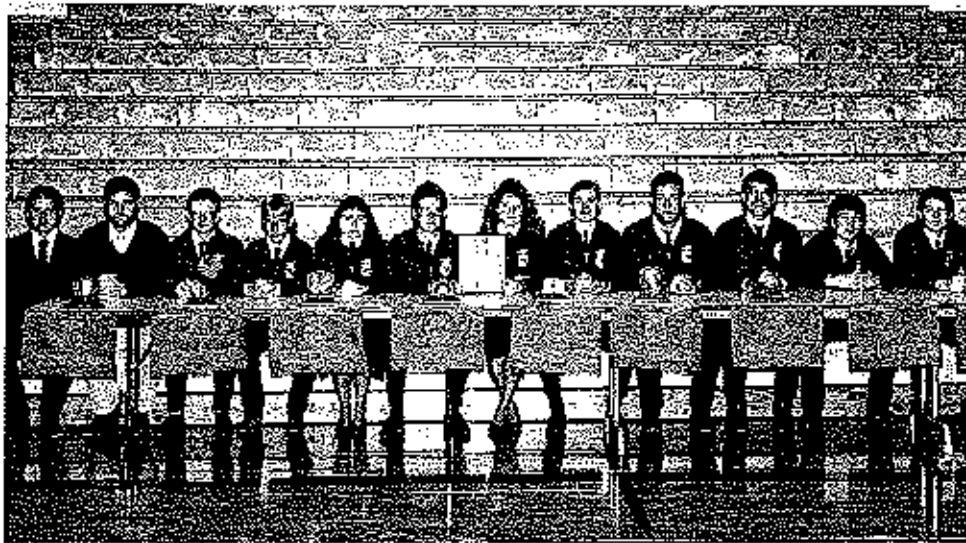

FFA Officers are: Advisor, Willard Hailey and Matt Biddle, Reporters, Jay Enloe and Sean Petet, Secretary, DeAnn Crouch, President, Scott Little, Vice-President, Nicolo Henley and Darin Banner, Treasurer, Joe Martin, Sentinel, Danny Kleithermis, Parliamentarian, Robert Haynes, Chaplin, Todd Opie.



Trip to W

Combining hard work both in and out of class paid off this year for the local FFA chapter. Students received top honors at the local, district and state level.

Early in the year, new members were initiated into the club through the traditional green hand ceremony. In the fall students also worked on projects, prepared a float for homecoming and attended leadership conferences.

Or
ofth
tunif
tion
Kan
time
ceiv
Farr
est
chaj
ceiv
Tim
wa
Que
juni
seni



ng PLACES

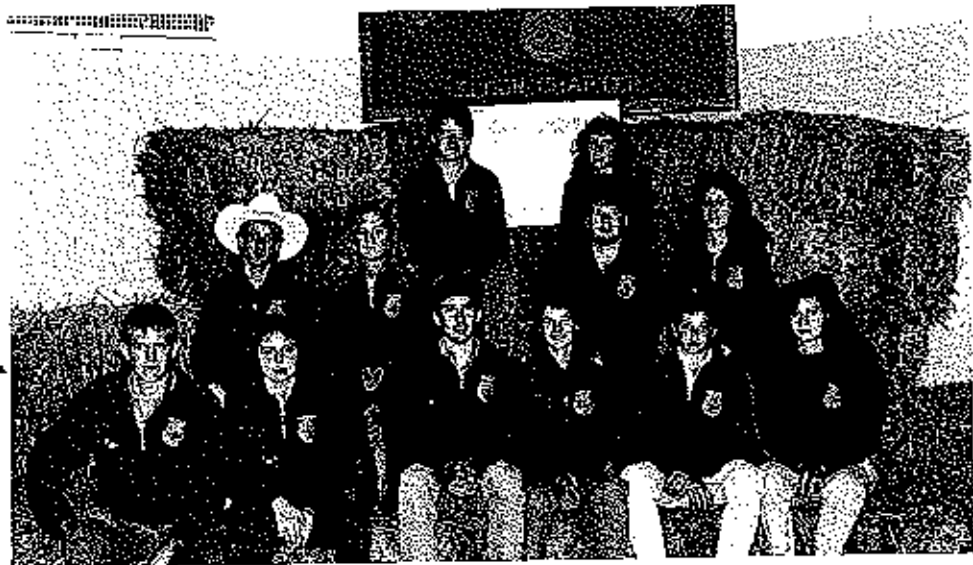
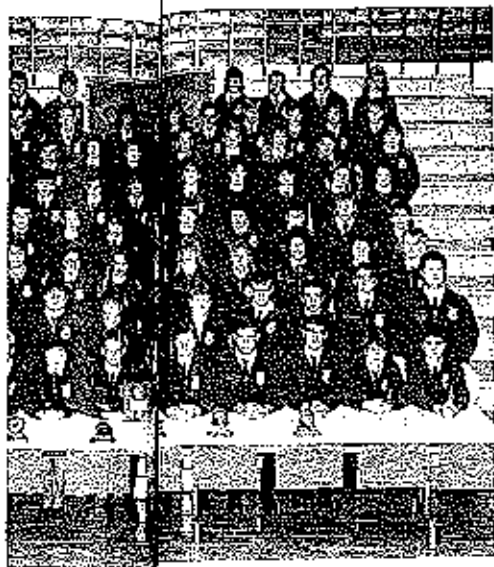

Barnwarming Court consisted of King and Queen, Nicole Henley and Scott Little, Attendants, Sean Petet, Stacie Hager, Cory Stark, Paula Benne, Jamis Neth, DeAnn Crouch, Troy Taylor, Christie Martin, Jandon Albertson, and Holly Morris.

ip to Washington

ard work.
of class
ar for the
ster. Stu-
top hon-
.. district

year, new
initiated
ough the
en hand
e fall stu-
rked on
ed a float
and at-
ership

One of the highlights of the year was the opportunity to attend the National convention in Kansas City. At this time, one student received his American Farmer degree, the highest honor awarded to chapter members. Receiving the honor was Tim Blankenship. Barnwarming King and Queen for the year were junior Nicole Henley and senior Scott Little.



FHA is active

During the year Eldon's chapter of Future Homemakers of America was very active at the local, district, state and even national level.

Under the leadership of sponsors Patty LaDuke and Linda Simon, chapter members worked throughout the year to prepare for contests and presentations at these levels. One member, Mendy Davenport, worked to become elected to a statewide office.

Officers for the group included President,

Kristi Miller; Vice-President, Jenny Schmitz, Historian, Nicki Zordel and Region 13 President, Mendy Davenport.

Projects for the year included a Haunted School that provided a safe place for elementary children to trick or treat, a hat and mitten tree at Christmas that provided items for needy families and co-sponsoring a lock-in, dance and roller skating party with the EHS Student Council in the Spring to reward active members in both groups.

One FHA sponsor Linda Simon conducts a portion of a meeting to determine plans for regional meeting.

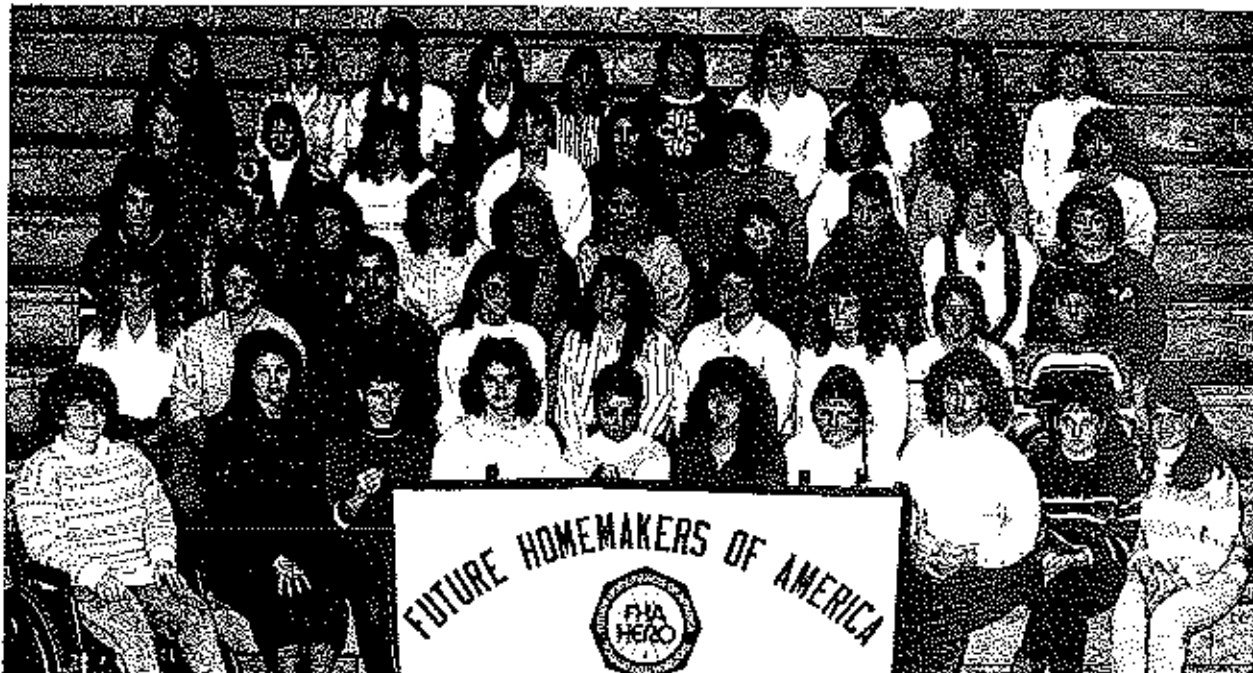

FHA members include. first row: Kathy Wright, Jenny Schmitz, Lisa Pope, Kim Benne, Leslie Davenport, Nicki Zordel, Lisa Martin, Christie Miller, Mendy Davenport, Vicki Crider, Dixie Sledbottom, Janice Clark, Dale Smith, Renee Pope, Stacie Hammond, Karl Miller, Stephanie Hammond, Tasha Farley, Lisa Wright, Jenny Reid, Melissa McDaniel, Robin Hutcherson,

Carrie Kitchel, Wendy Booth, Shella Clark, Dana Nichols, Pauley Porter, Kelly Kinney, Tanya Farley, Shannon Spalding, Marsha Robbuck, Cindy Trenary, Derreca Wood, Lola Light, Sue Myers, Jennifer White, Rosie Butler, Patty LaDuke, advisor, Angie Borgardt, Angie Asher, Melissa Medlock, Christy Burris, Danise Reed, Amy Howell, Linda Simon, advisor.

De
Res:
United
a natio
crease
prison
United
That
1989-9

Front
Atwell,
Wells,
non Sc
chin, &

David
spends
ing his

Debate squad competes

Resolved: That the United States should adopt a nation wide policy to decrease overcrowding in prisons and jails in the United States.

That was the topic for the 1989-90 school year for the

Eldon High School Debate Squad.

In a debate round students are either affirmative or negative. The affirmative team presents arguments supporting the resolution, and the negative

team presents arguments opposing the resolution.

Throughout the year the team traveled to tournaments at Hickman, Buffalo, Waynesville, Rockbridge, and Districts in Rolla. At Buffalo the novice

team of Jessica Oswald and Chris Parr received a second place trophy. Also, the novice team of Shannon Schekorra and Mike Hawken received a third place trophy.

When a debate team goes to a tournament there is more than one event to compete in. There is extemporaneous speaking, which is going into a round, drawing a topic, and then having 30 minutes to prepare a winning speech. Another event is Original Oratory in which a person gives an eight minute speech which they have memorized. There are also two debate events. They are Original debate and Lincoln-Douglas debate. Original debate is two on two man debating and Lincoln-Douglas debate is a man on man debate.

In Debate class the students do such things as prepare and go over their cases, classroom debates, and they research the topic for as much evidence as possible. This year the class chose Tyrus Czeschin as Squad Captain.



Front Row: Beverly Witt, Jeff Hoffman, Sean Atwell, Missy Lupardus. Second Row: Clayton Wells, Jerad Langley, Darla Davenport, Shannon Schekorra, Mandy Davenport, Tyrus Czeschin, Misha Gensert. Third Row: Chris Parr,

Jessica Oswald, Mike Hawken, Jimmy Hendricks, Larry Salsman, Anthony Opie, Tony Ancoll, Nicole Adams, Brian Rogers, Brandon Cornaby, David Bailey, advisor.



David Bailey, Debate advisor, spends many long hours helping his students.



Jeff Hoffman, Chris Parr, Anthony Opie, Jessica Oswald, Darla Davenport, Mike Hawken, Shannon Schekorra, Angela Green, and Larry Salsman, all seniors, gather for a spirit shot during a Debate tournament.

Brian Rogers and Jerad Langley, juniors, study their Debate case during class.



The Eldon High School Drama Club was represented this year by 40 students who contributed to the club by acting, running the light and sound system, set construction, and make-up and costumes. The 1989-90 Drama Club presented two plays. "Makin' It" was presented November 9th and 10th and "The Mouse That Roared" was presented April 25th and 26th. Both plays had a large cast due to the number of people in Drama.

At the Drama Banquet on May 10th the following awards were given to people for their hard

work in Drama. Oscar went to Chris Parr. Best Actor went to Brandon Cornaby. Best Actress went to Deanna Rogers. Best Supporting Actor went to Byron Cato. Best Supporting Actress went to Shannon Schekorra. Best New Talent went to David Abbott. Most Improved went to Brian Rogers. The Fruit Of The Loom Award Award went to Sean Atwell.

The officers elected for this year were: President, Charlie Tompkins; Vice-President, Carla Purdon; Secretary, Jerad Langley and Drama Club Representative, Darla Davenport



Brian Rogers, junior, works on the light board during play practice.

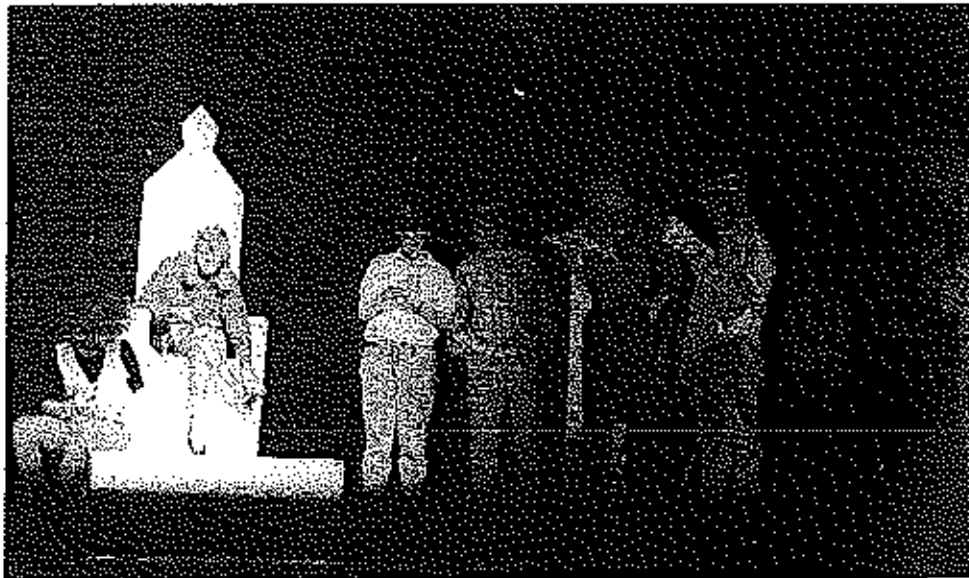

Dixie Miles, senior, Amanda Hedden, senior, Brandon Cornaby, junior, Charlie Tompkins, senior, Chris Parr, senior, and Malissa McDaniel, sophomore, practice for "The Mouse That Roared."



Amanda Hedden, senior, Darla Davenport, senior, Jerad Langley, junior, Troy Taylor, sophomore, Brandon Cornaby, junior, prepare to present "Makin' It"



Seniors Amanda Hedden and Deanna Rogers prepare junior Brandon Cornaby for the Homecoming Parade. It has become tradition for the drama students to dress as clowns in the parade.



senior, Darla
s, Jerad Lan-
Taylor, soph-
Cornaby, ju-
present "Ma-



Members of Drama, front row: Lisa Breshoars, Darla Davenport, Sus Myers, Amanda Hedden, Shannon Scheskorra, Jerad Langley, Robin Hutcherson, Dawn Hawken, Jennifer Matrow, Joy Williams, Deanna Rogers, Kelly Schubert, Erica Gee, Jolene VanHooser, Molly Wirts, Kristi Dennis, John Merriman, Scott Christian, David Abbott, Nicki Zordel, Brandon Cornaby,

Stacey Rader, Dixie Miles, Kierstan Jones, Carla Purdom, Charlie Tompkins, Sean Atwell, Kevin Jeffries, Troy Taylor, Kim Zupanoic, Jerrod Atteberry, Holly Forester, Christi Miller, Lori Christner, Brian Rogers, Angela Procter, Chris Parr, Jason Burks, Tracey McGray, Byron Cato.

Staffs record news

Both Publications and Journalism staffs are responsible throughout the year for recording the news and events of the high school. Student reporters learn to report news as accurately and fairly as possible and come to understand the need for working throughout the year to meet their deadlines. They weren't always successful!

Technically, Journalism students work to produce the Maroon and Gold, the student newspaper that is published twice a month in the Eldon Advertiser.

The Publications II staff is responsible for the production of the yearbook, the Referet. Students learn to draw layouts, write copy, count headlines and take and develop pictures in Publications I.

The editor for the 1990 Referet was senior Cindy Atteberry and the assistant editors were Deanna Rogers and Stacie Hager.

The staff for the Maroon and Gold for 1990 consisted of:

Editor: Jenny Ressel

Assistant Editor, News: Deanna Rogers

Assistant Editor, Production: Jolene VanHooser

News Editor: Tyrus Czeschin

Features Editor: Kim Marriott

Sports Editor: Shannon Schekorra

Layout and Design Editor: Shelly Pfantz

Photography Editor: Darla Davenport

Reporters: Derek Dummermuth, Stacey Edgar, Erica Gee, Amanda Hedden, Keith Boyd, Kara NovoGradic, Rebecca Wall, Nicki Zordel, Angel Hardin, Stacey Rader.

Members of the Editorial Board: Jenny Ressel, Deanna Rogers, Jolene VanHooser, Tyrus Czeschin, Shelly Pfantz, Darla Davenport, Amanda Hedden, Erica Gee, Nicki Zordel.



Members of the Journalism staff for 1989-90 were, from the front Rebecca Wall, Angel Hardin, Keith Boyd, Stacey Edgar, Derek Dummermuth, Chris Spencer, advisor, Nicki Zordel, Amanda Hedden, Kara NovoGradic, Chris Dilly, Shannon Schekorra, Darla Davenport, Kim Marriott, Shelly Pfantz, Tyrus Czeschin, Jenny Ressel, Deanna Rogers.

Senior Publications II staff member Darla Davenport works on her layout and design with the use of the Comtran computer program.

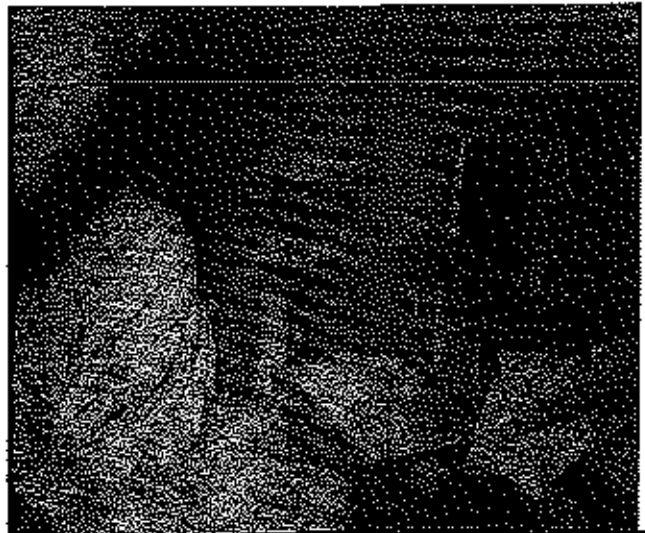

Pa
na
le
ar
ce

Mem
row: 1

Publication and Journalism Staff members participated in many other activities throughout the year including cheerleading, Student Council and others. Shannon Schekorra and Deana Sexton participate here in Pajama Day for Homecoming Spirit Week.



Watching a demonstration from Walsworth Publishing Co. representative Paul Magain are students Tyrus Czeschin, Deanna Sexton, Carla Purdom, David Saint.

from the front
Edgar, Derek
del, Amanda
Schekorra,
Czeschin,

works on
computer pro-



Members of the Pub II staff for 1990 were front row: Deana Sexton, Carla Purdom, Kieratan Jones, Shelly Pfantz, Stacey Rader. Second row: Darla Davenport, Jerry Wood, Cindy Attsherry, Deanna Rogers, Stacie Hager.



EHS

SPORTS

WHERE DO WE GO
FROM HERE?!



Senior cheerleaders Shannon Schekorra, Deana Sexton, Kim Marriott



White Squad cheerleaders Laura Pemberton, Jolene VanHooser, Sheryl Eth, Molly Frye, Erica Gee, Jonny Hoark, Christina Barfield, Karissa Thompkins



Gold Squad cheerleader perform a pyramid for time out during a game.

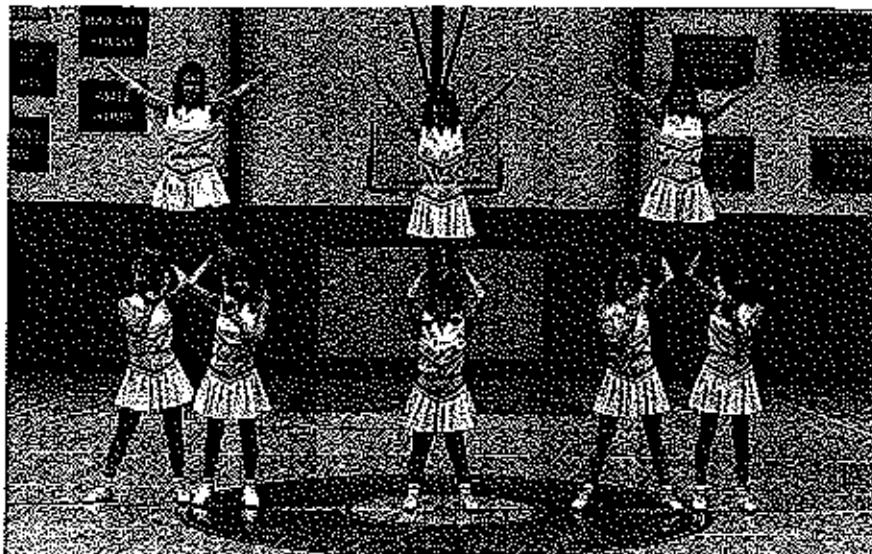

Maroon Squad Cheerleaders Deana Sexton, Marcia Milburn, Shannon Schekorra, Sasha Scott, Shelly Cole, Kim Marriott, Kim Mayfield, Dawn Hawken

spi
cvs
at
in
ch
ch
wa

we
lea
ch

po
at
ba
fo

ha
tes

of
of
wi
ses

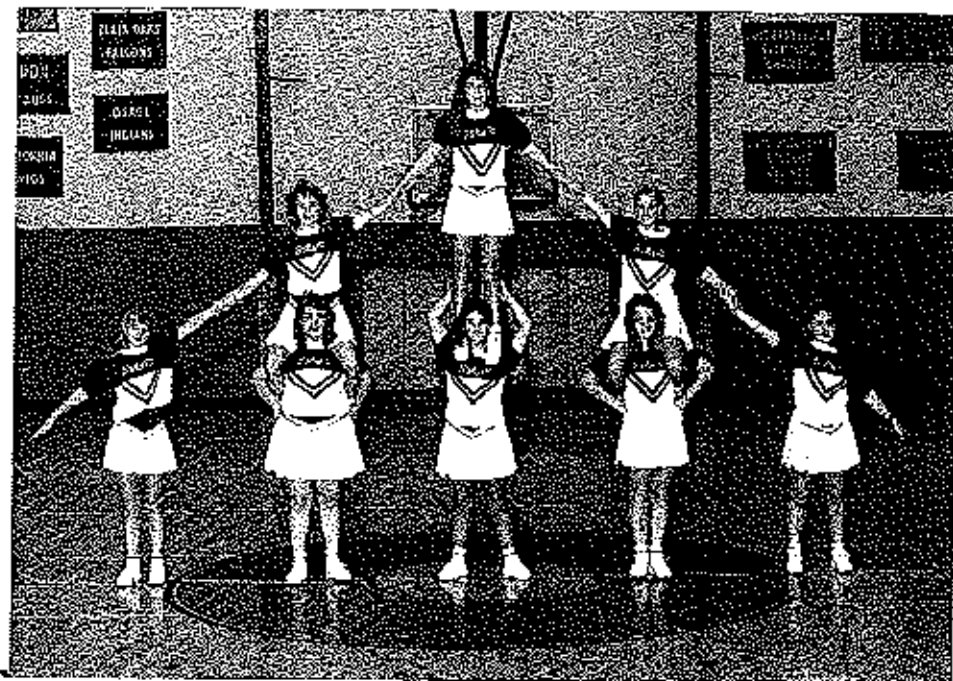

Gold Squad cheerleaders Melissa McDaniel, April Ballenger, Misha Ginsert, April Hill, Leah Twyman, Stephanie Luivan, Heather Hayes, Dawn Rond

Maroon Squad cheerleaders get the crowd into high spirits at a home football game.

Keeping the Spirit Up

The EHS cheerleaders have been keeping the spirit high this year. Before the sports season ever started they attended cheerleading camps at NCA in Marshall, ICF in Columbia, and DCA in Warrensburg. They learned new dances, cheers, chants, jumps, and pyramids. At NCA cheerleading camp in Marshall Kim Marriott was named All-American Cheerleader.

Cheerleaders also had a mini-cheer clinic where kids from south school and junior high learned how to do jumps, gymnastics, cheers, chants, and stunts.

When the season started cheerleaders supported all of the teams. The cheerleaders danced at the Turkey Festival, had a float for the Football Homecoming parade, and performed dances for Tournaments.

They decorated lockers, put up posters, and handed out flowers and candy to all of the teams.

For a lot of the cheerleaders cheering is one of their favorite things to do. "Cheering is a lot of hard work, but we are all like sisters; that is what makes it a lot of fun," says Deana Sexton, senior.



Cheerleaders perform a skit for homecoming pep assembly.

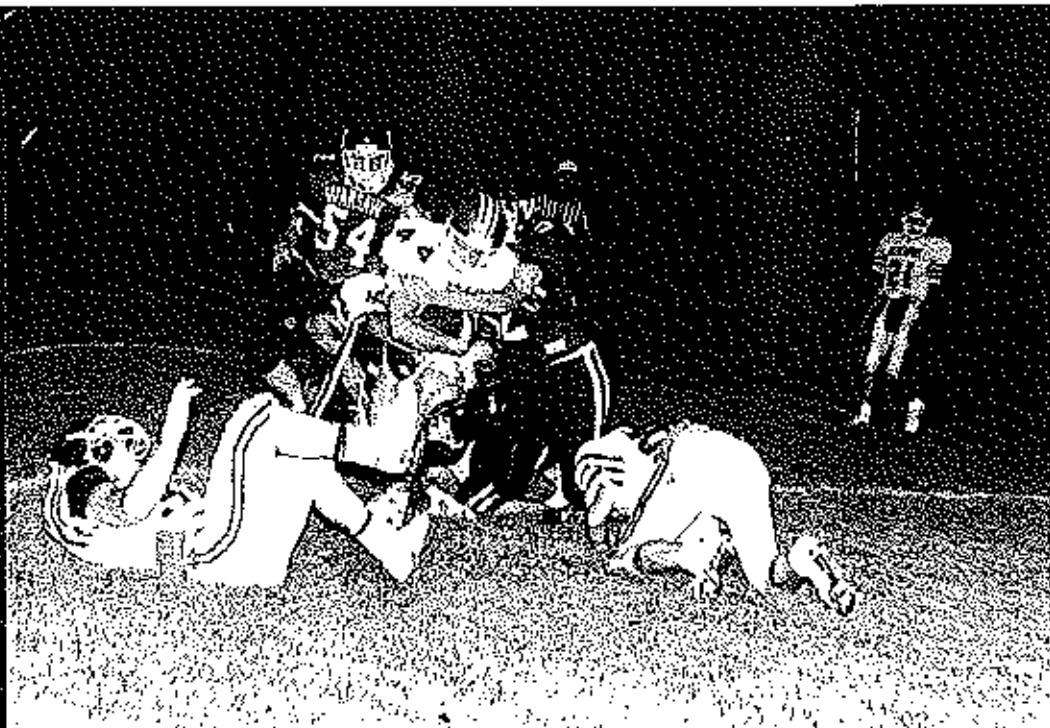

Aaron Bowen, junior, fights through Warsaw's defensive line.



Aaron Bowen, junior, hangs on to the ball, as Tyrus Czechis, senior, holds defensive tackle.

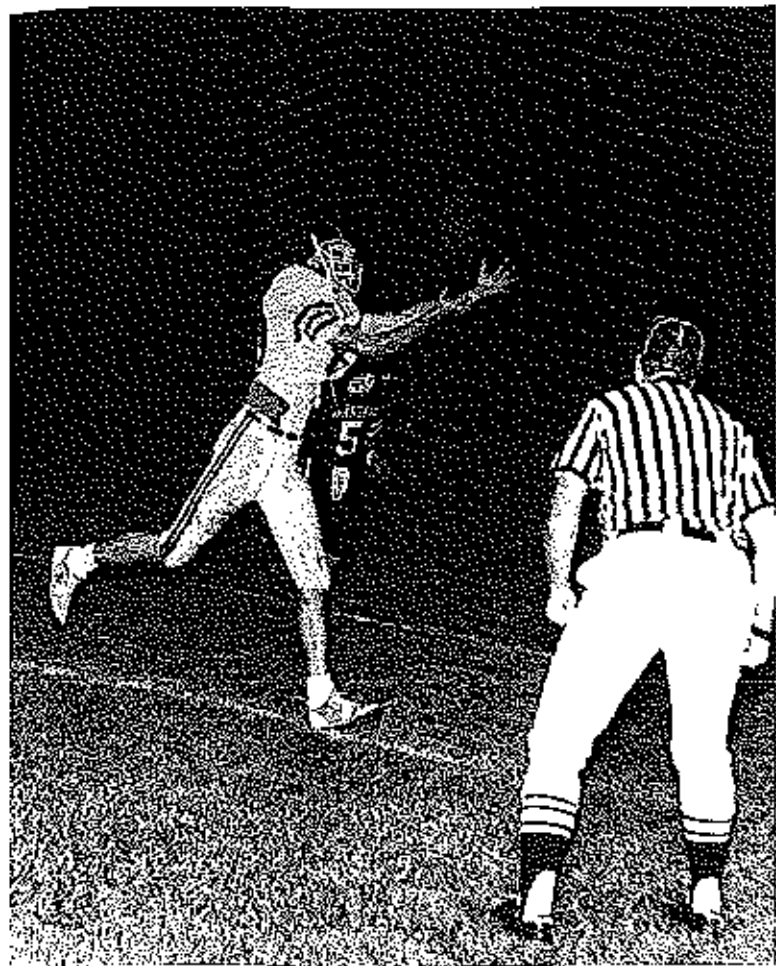

Scott Ellerman, senior, struggles to receive the pass.



Scott Ellerman, senior, fights off the defensive opponents to keep the ball.

Front
Middle
Back
Kyle
Edge
Third
Special
Line
Steer
Eric
Alton
Don C
my
Mara

Stangs Suffer Defeat

The Eldon Mustangs' Football Team stumbled out of the gate in 1989. Graduation from last year's Tri-County Conference Championship and class 3A District 8 Championship team had hit the team hard, and preseason injuries and injuries in the first few games wiped out some of the remaining talent.

The result was a small record of 3-7, 3-3 in the Tri-County Conference. But with just a few starters graduating, and with a year of healing, Eldon could again rise and be a force both in the conference and the district play.

Members of the Eldon Mustangs' Varsity football team who were named to the Tri-County All-Conference team were, Thadd Buster, honorable mention defensive tackle; Scott Spears, honorable mention receiver; Darrell Kreiling, second team linebacker; Steve Henderson, second team punter; Shawn Abbott, honorable mention center; Cory Stark, first team defensive guard and second team offensive guard; Duane Rush, first team defensive tackle; Darin Strood, second team defensive back; Scott Ellerman, first team wide receiver and the only unanimous selection on the entire Tri-County Conference squad; Brad Cato, honorable mention defensive end; Bryon Cato, second team defensive end; and Kyle MacFadyen, second team place kicker.

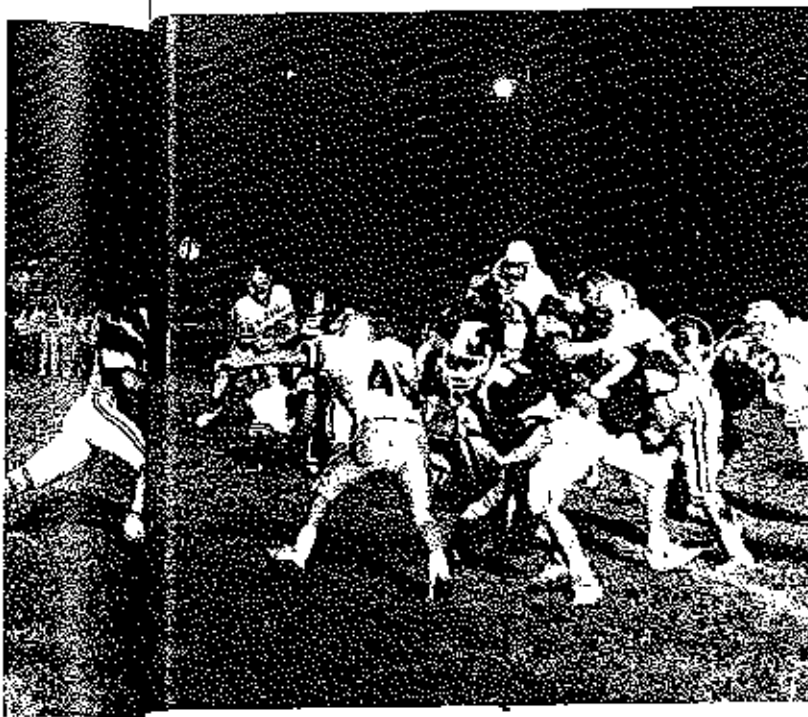

...to the ball, as defensive tackle.



Front Row: Mark Amisinger mgr., Bryon Cato, Mike Morgan, Jason McGray, Mark Serivner, Jerry Wood, Tytus (Zerubin), Dain Burd, Brad Cato, Scott Ellerman, Second Row: Todd Durle mgr., Kyle MacFadyen, Tony Hoffman, Cory Stark, Duane Rush, Ke Claridge, Shawn Abbott, Duane Witt, Darrell Kreiling, Keith Boyd, Third Row: Jeremy Spratt, Matt Wycick, Shannon Wood, Scott Spears, Thadd Buster, Walker Claidge, Rodney Bashore, Joe Hartwick, Fourth Row: Aaron Hibdon, Josh Smith, Tim Wood, Steve Henderson, Mike Jetterles, Seth Busch, Monah Lucharepet, Eric Hibdon, Philip Holland, Sam Casender, Marty Rush, Donald Alden, Ty Cobb, Jon Lambeth, Matt Colby, Laundon Apperson, Brandon Opie, Harold Franzen, Mike Lexa, Travis Opie, Chris Newton mgr., Coachs Clyde Klein, Andrew Moore, Head Coach Gary Marclott, Chuck Campbell

...keep the ball.

SCOREBOARD

Opponent	Opp/EHS
Camdenton	21-6
Warsaw	6-3
Osage	8-0
California	19-7
Tipton	0-21
Versailles	0-21
Blair Oaks	0-21
Macon	15-18
Fulton	41-7
Bonville	28-18

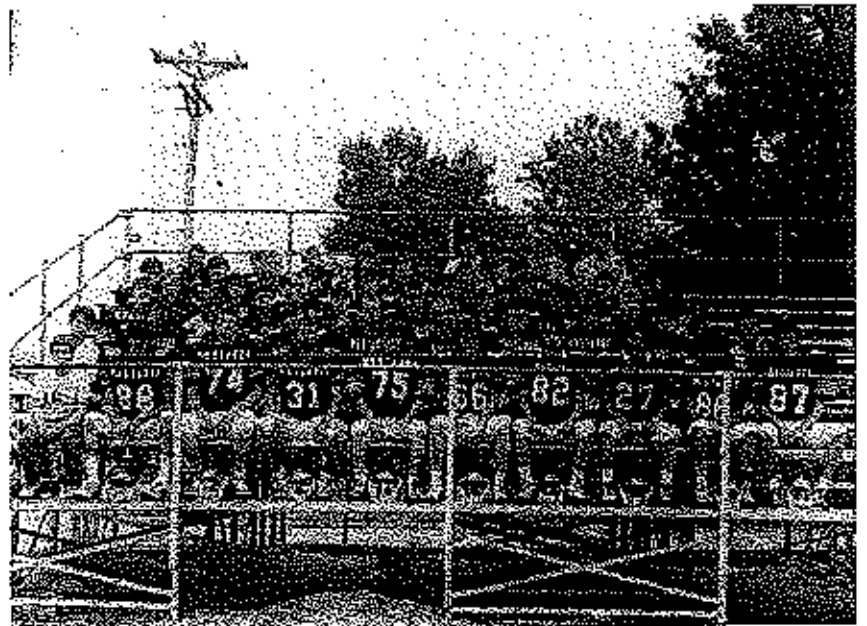

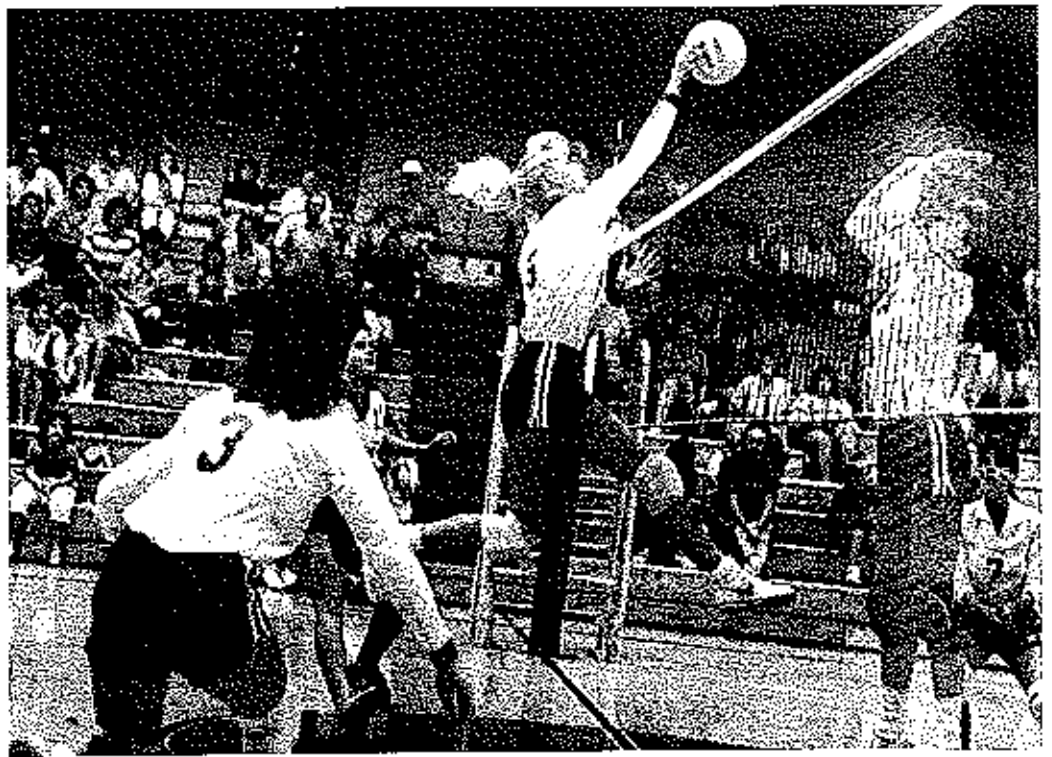

Carla Purdom, senior, executes a power spike against the Jefferson City Jays.

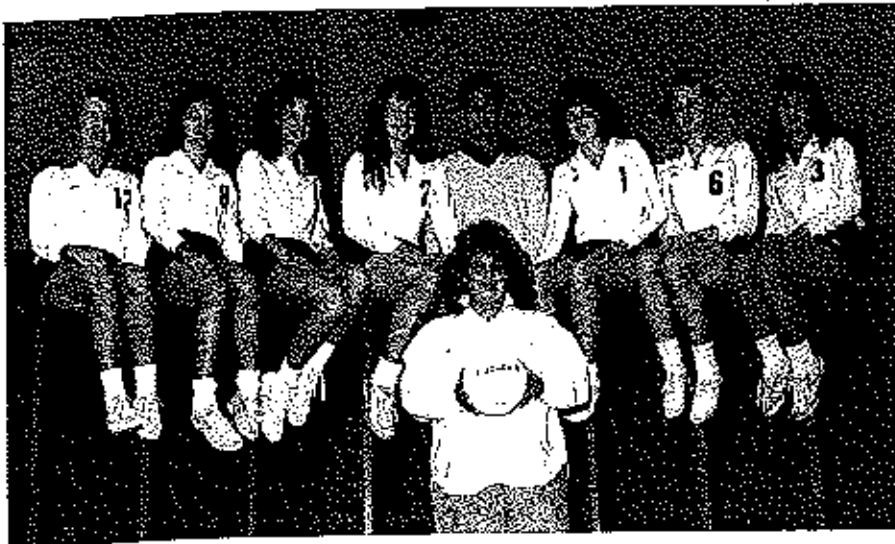

Freshman Girls Volleyball, in front, manager, Julie Crouch, Jill Jones, Heather Dinwiddie, Regan Faceaire, Susan Edison, coach, Todd Shockley, Lori Suttie, Melissa Hull, and Jennifer Bonafacio.

SCOREBOARD

Opponent	EH&Opp	Opponent	EH&Opp
Hormona	15-10, 15-3, 8-15	Odessa	15-0, 15-7
Warsaw	15-0, 15-2	Santa Fe	15-0, 15-2
Cole Camp	15-11, 15-1	Truman	15-3, 15-3
California	15-5, 15-2	Kickapoo	15-3, 15-4
Tipton	15-2, 15-2	Rock Bridge	15-3, 15-2
Hick Oaks	15-2, 15-3	Borgia	15-12, 12-15, 9-15
Moraine Tournament	Second Place	Camdenton	15-3, 15-6
St. Charles	15-3, 15-24	Buffalo	15-7, 15-6
Farkway North	15-1, 15-10	District Tournament	First Place
Uxalino	15-2, 15-0	Mooreville	15-3, 15-2
Nashville	15-3, 15-4	Camdenton	15-4, 15-1
J. C Jays	15-11, 15-10	Sectionals	
Durbin	15-10, 15-3	Keamey	14-14, 14-11
Uxalino	15-16, 13-15	Oak Grove	14-17, 15-5
I. C Jays	15-10, 15-4	State	Third Place
Vandalia	15-10, 15-2	Borgia	11-15, 10-15
Osage	15-3, 15-2	Duquesne	8-15, 8-15
Warrensburg Tournament	First Place	Monett	9-15, 11-15
Turman	15-4, 15-14		15-13, 7-15, 15-7
Santa Fe	15-2, 15-2		
Lee Summit	15-0, 15-5		



Beth McKinley, sophomore, goes down for a save.



The 1988 Varsity team: first row, Amy Webster, Diana Davis, second row Coach Todd Shockley, Herb McKinley, Maribeth Crain, Coach Ann Leutkensyer, third row, Marsha Duncan, Cindy Atteberry, Jessica Oswald, Lynus Henley, top row, Melinda Wrye, Carla Purdom.

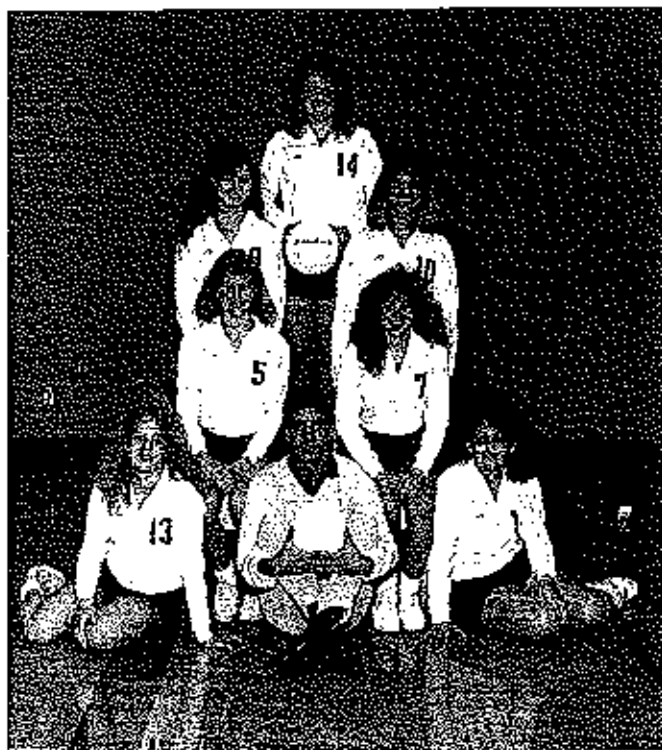

Members of the Junior Varsity team, first row, Jennifer Dietrich, Coach Todd Shockley, Jennifer Lovelace, second row, April Daniels, Angie Miller, third row, Holly Morris, Holly Geiswald, top, Connie McDevitt.

S-T-A-N-G-S Spell Success

The Eldon Lady Mustang Volleyball Team was going to face a tough job of rebuilding after last year's second place finish at State in class 3A. The Lady Mustangs faced the new season with one of the youngest teams. They all pulled together and once again went to State with a record of 34-2-1. The Lady Mustangs took their fourth straight trip to the Show-Me Spike-O-Rama Final Four. Eldon was intent on another great finish and possibly winning the whole thing this year. Losses to St. Francis, Borgia, St. Charles, Durchene and Monett knocked Eldon into third place.

The Lady Mustangs rebound to win that contest and finish the third-best Girls' Class 3A Volleyball Team.

Melinda Wrye and *Cindy Atteberry* of the Lady Mustangs Varsity were named to the Class' 3A All-Regional and All-State Teams.

Named to the Class' 3A District 13 First Teams were *Melinda Wrye*, hitter, *Cindy Atteberry*, setter, *Maribeth Crain*, hitter, *Carla Purdom*, hitter.

Mustangs finish 27-1

Winning was the name of the game at Eldon High School this year as the team finished with a 27-1 record. The boys basketball Mustangs entertained fans with some exciting games.

In the California Tournament and Eldon Tournaments the Eldon Mustangs brought home the championship trophies. But that championship did not come easily. The five starters consisted of all seniors, who have played together since junior high. Since the start of the season they had it in mind to make it all the way to district and state finals. They made it to district but it stopped at sectional play with a lost against Willow Springs. This loss was the first of the season and the hardest to bear for the basketball players and the devoted fans of Eldon High.

This years senior basketball players were: Darin Banner, Scott Ellerman, Jeremy Frye, Mike Garrett, Mike Langston, Roger Mitchell, Joel

Vaughn.

Junior, Shawn Wood said, "I liked playing with this years seniors. I gained experience that I will use next year. I hope we, the 1990-1991 basketball team, can achieve all that we did with the 1989-1990 team." The Boys Basketball coach is Fred Norman.

In celebration of their winning the District Finals, senior Darin Banner takes his turn at cutting down the net. Senior, Joel Vaughan, looks for an opening against the Smithton Tigers.



The varsity team: front row - Jeremy Frye, Joel Vaughan, Scott Ellerman, Darin Banner, Roger Mitchell, Mike Langston, Shawn Wood, manager Todd Burris; back row - Coach Fred Norman, manager Jimmy Hendricks, Steve Henderson, Mike Garrett, Jamie Neth, Thadd Buster, Terry Blankenship, manager Matt Amsinger, Coach Todd Shockley, manager Galen Hayes.



Senior Roger Mitchell attempts to stop a Fulton lay-up.

MUSTANGS
27
WINS
1
LOSS

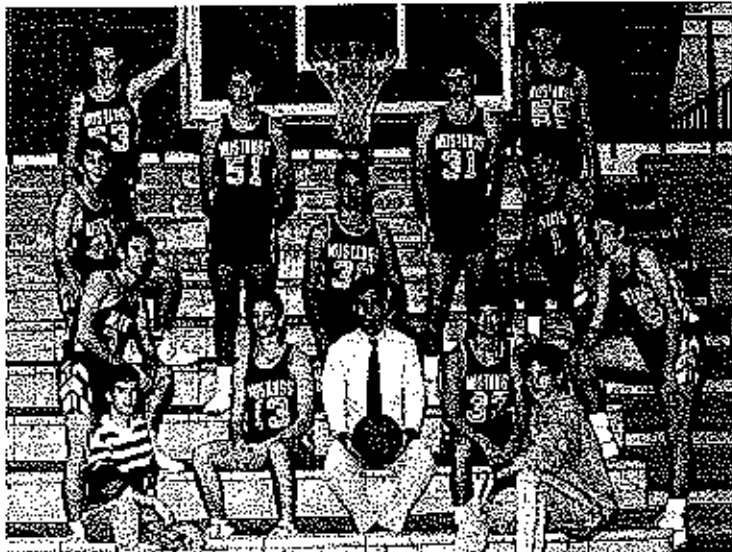

The Junior Varsity team: front row - managers Galen Hayes and Todd Burris; second row - Terry Blankenship, Scott Spears, Coach Todd Shookley, Tim Wood, Steve Henderson; third row - Jarod Pratt, Thadd Buster, and Jerrod Atteberry; fourth row - Zane Stevenson, Matt Wyrick, Jamie Neth, and Brian Dawson.

eromy Frye, man, Darin Langston, Todd Burris; in, manager Henderson, Thadd Buster, nager Matt Shookley, man-



The Freshman team: front row - Jimmy Myers, Scott Hollis, Philip Holland, Matt Dolby, Robert Wall, Harold Franklin, Donald Aldin, and Marty Rush; back row - Eric Pearson, Russel McDowal, Doug Porter, Cory Runyan, James Ressel, Matt Lee manager, Ty Cobb, and Pouch Intharaphet.

Seniors Going On

The Eldon Lady Mustangs ended their season with a record of 22-5. They ended by being the Tri-County conference and district champions. Their season completed with a sectional play and with a loss against the State champions, Marshfield Blue Jays.

The Lady Mustangs participated in the Eldon, Versailles, and Russellville tournaments, Lady Mustangs were on top in all of them.

Coach Claire Herri-man attributes the success of the team to the seven seniors: Cindy Atteberry, Sara Carrender, Stacey Fair, Stacie Hager, Jessica Oswald, Carla Purdom, and Melinda "Minnow" Wrye. "... we ended up finishing so well in conference and district because of the leadership of these seven. The pressure did not seem to overwhelm them."

This proved to be a good ending to a four year stretch of victories for these seniors and for the students they represent at Eldon High School.

Junior, Shelly Pfantz comments "We worked hard and long for the victories that we achieved because they did not come as easy as some people might think. We had a lot of frustrating times but it all turned out for the good."

After the season, victories were still won as players received such notable awards as all-conference and all-American.

Junior Maribeth Crain looks for an open pass inside while playing the Hickman Cuples.



Senior Carla Purdom and junior Shelley Pfantz fight for possession of the ball at the Sectional game in Rolla.



The Junior Varsity team; front row - Christie Martin, Angie Morris, Amy Webster, Connie McDevitt, and Jenny Francis; back row - Dana Davis, Holly Morris, Beth McKinley, April Daniels, Holly Griswold, Jennifer Lovelace, and Coach Mike Hioke.

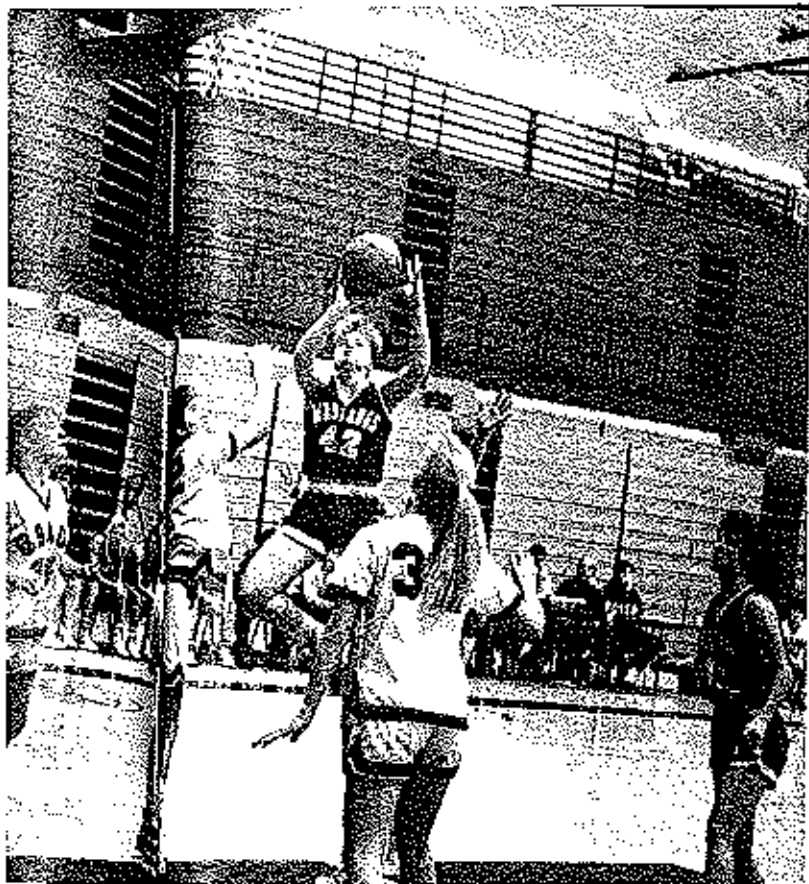

At Ossage senior Melinda Wrye shoots over an Indian defender.

Eidon	Opponent
87	Helias 61
83	Blair Oaks 34
83	Tefferson City 89
87	Waynesville 78
87	Hickman 88
89	California 58
40	Warsaw 48
52	Tipton 63
68	Ossage 63
78	Fulton 78
80	Versailles 63
81	Cole Camp 45
74	Camdenon 66
79	Patina 61
54	Helias 67

Eidon Basketball Tournament 1st

Versailles Basketball Tournament 1st

Russellville Basketball Tournament 1st

Conference Tournament 1st

District Tournament 1st

Sectionals Lost

32 wins 8 losses.



or Shelley the ball at

ow - Chris- Webster, Francis, y Morris, Holly Gri- and Coach



The Freshman Team: seated - Jennifer Lovelace, Holly Morris, Holly Griswold, managers Heather Medlen, Heidi Medlen, Marsha Robuak; standing - manager Melissa Schupp, Jennifer Pittreich, Coach Sandy Brooks, Jennifer Bonifacio, Denise Gibson, Melissa Hull, Renee Popo, Angie Miller, Lori Suttie, Heather Dinwiddie.

The Varsity Team: first row: Cindy Atteberry, Dana Davis, second row: manager Lucia Jones, Marsha Duncan, Mari-both Crain and manager Kierstan Jones, third row: manager Julie Crouch, Coach Clare Herriman, Stacey Fair, Stacie Hager, Beth McKinley, Coach Mike Hicks, manager Stacey Rader; fourth row: Jessica Oswald, Melinda Wrye; fifth row: Carla Purdom, Shelley Pfantz, and Sara Carrender.



Track Goes For the Gold, All the Way to State

Team standings weren't as high as everyone would have liked them to be, but what the team lacked in numbers, it made up for in talent. That was proven when junior, Maribeth Crain and freshman, Renee Pope both made it from sectional to state and showed what EHS could do.

Although low in numbers the boys track team had a success in several events. The 800 meter relay team and Darell Krieling with the shop put, qualified for sectional. While junior, Shawn Wood advanced all the way to state to take seventh place in the triple jump.

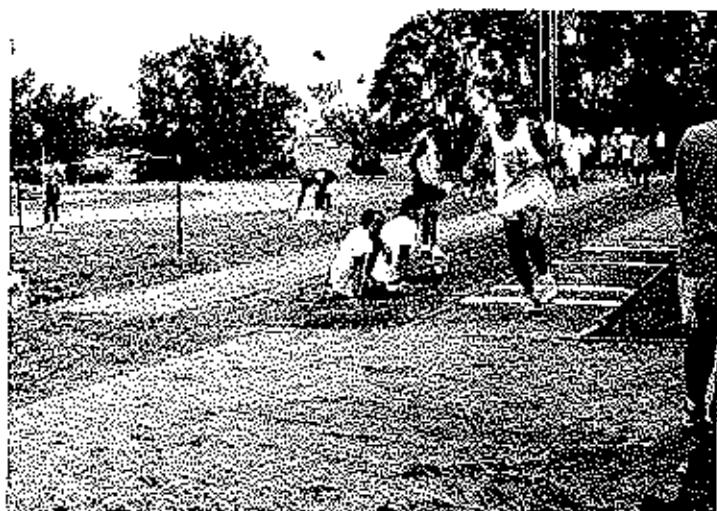
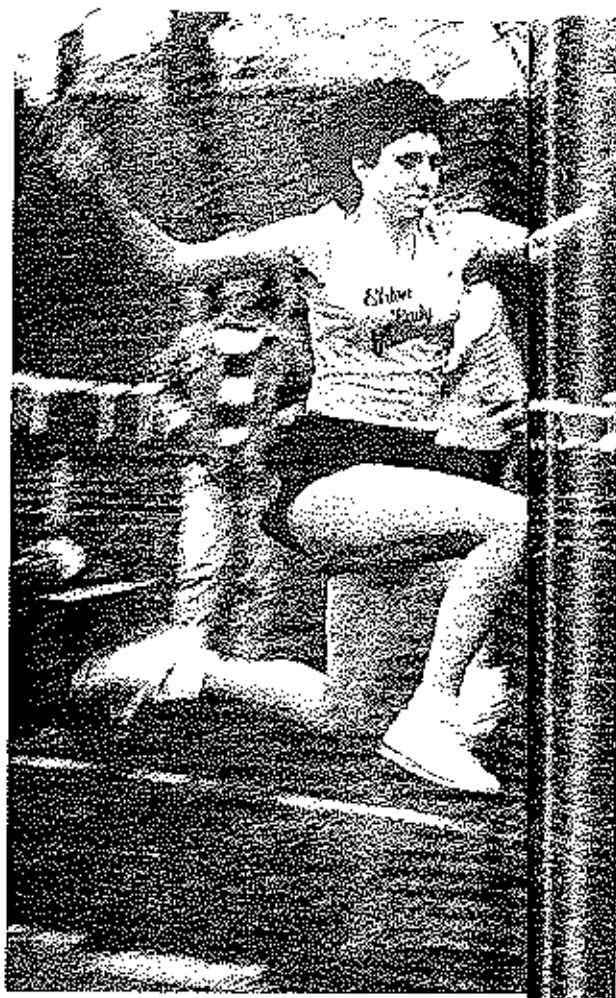

Junior, Shawn Wood participates in Show-Me games in the summer of 1990.
Senior, Clafy Axtberry tries to extend her jump as far as she can on her last attempt.



State

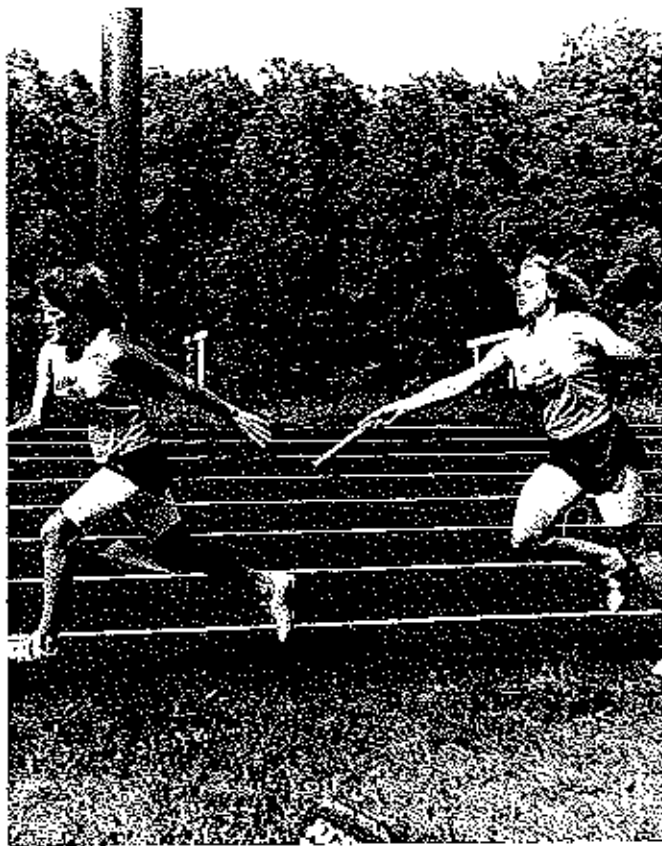

Joyona, Maribeth Crain and Shelly Ifantz contribute the team with their speed and dedication.



The Eldon golf team accomplished much this 1990 year. The varsity won the championship in conference and district play, they also ended their season with fourth place in state.

The Varsity had three returning lettermen with two other new players. The returning lettermen were as follows: junior, Darin Bond; senior, Mike Hawken; senior, Larry Salsman. The new players added to the Varsity team were freshman, Cory Runyan and senior, Kyle

MacFayden. The following made all conference and all district golf team Darin Bond, Mike Hawken, Kyle MacFayden, and Larry Salsman.

Mike Hawken commented on state play he said, "We had a chance of placing first or second in state meet but because of the weather on the second day we ended with our score that we had ended with on the first day. But we they were fourth place just behind third place by a couple of strokes."

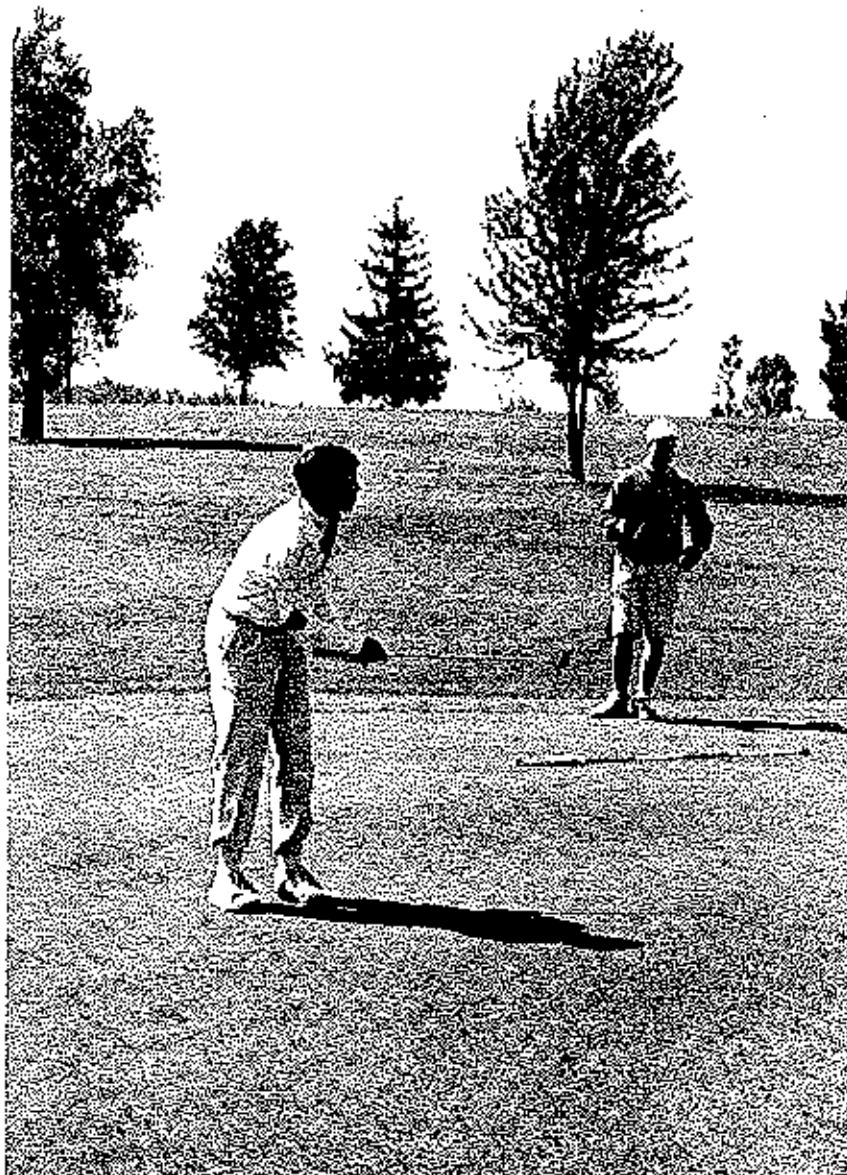

LEFT - Darin Banner putts the ball for an even par.

ABOVE
ready
Jeff



RICH
and f

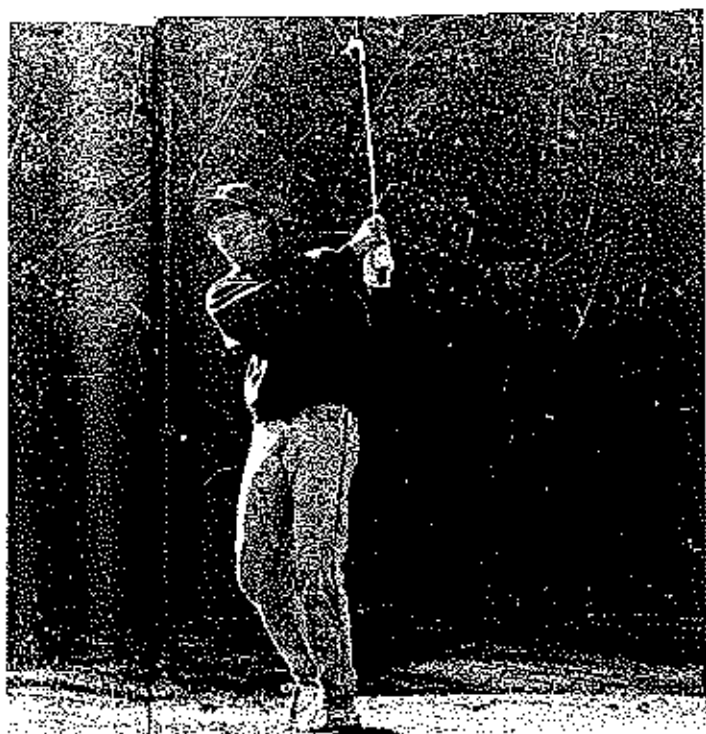

ball for an

ABOVE - Larry Salsman a returning lettermen gets ready before the beginning of a golf match against Jefferson City Jays.



RIGHT - Larry Salsman chips the golf ball on to the green for a birdie and hopefully a win for the Eldon golf meet.



**Eldon Golf At Its
Best Comes With
Returning Lettermen**

Homecoming leads to a memorable evening

This year's basketball homecoming fell on Friday, February 9. The evening began with the junior varsity team winning their game against the California Pintos with a score of 51 to 19.

Between the j. v. and varsity games, the coronation ceremony for the queen of popularity and beauty took place. First, the 1988-89 homecoming queen, Melanie Scott, was escorted onto the floor by senior Scott Ellerman.

Then came the freshmen maids wearing turquoise for their color. Donald Aiden escorted Kim Mayfield, and Jennifer Bonifacio's escort was Phillip Holland.

The sophomores wore royal blue gowns. Molly Frye was escorted by Zane

Stevens, and Steve Henderson was the escort for Stephanie Leivan.

The juniors came in next. Jamie Neth escorted Sasha Scott, and Stacie Hammond had Shawn Wood for an escort. Their color was magenta.

Lastly came the three senior candidates wearing the traditional color of white. The princesses were Shelia Blomberg, escorted by Roger Mitchell, and Darla Davenport, escorted by Darin Banner. Joel Vaughan had the honor of accompanying the new 1989-90 queen, Carla Purdom.

The varsity team then beat the Pintos with a score of 86 to 41, improving their record to 21-0. After the game a dance was held for all students and alumni.

"It was a real honor and it was definitely the most memorable part of my four years at EHS," remarked basketball homecoming queen Carla Purdom.



Junior maids were Stacie Hammond and Sasha Scott.





Nervously awaiting the coronation ceremony are senior queen candidates Darla Davenport, Carla Furdom, and Shelia Blomberg.

Senior Scott Ellerman had the distinguished honor of escorting the 1988-89 homecoming queen, Melania Scott.



Should homecoming be more formal?



"Yes. It makes the whole thing a little more special and adds to the atmosphere," said junior Cindy Cortaville.

Sophomore Joe Hoffner commented, "No, because it wouldn't be comfortable to sit through a whole game in a suit."



Freshman, Kim Green, stated, "Yes, because a lot more activities went on this year."

Senior, Byron Cato, quoted, "No. I didn't like the way the school used our senior class as an example for everyone else, like not letting us out early for graduation."



The freshman maids were Kim Mayfield and Jennifer Bonifacio and sophomore maids were Molly Wirts and Stephanie Leivan.

and and

Where did we take ourselves?

In order to find out where we go from here, we have to first see where we took ourselves to get where we are now. Each person took their own road in life, however, many roads were shared at different points by many students.

Many students chose to spend their time being involved in organizations and activities. Sometimes the activities were designed to help the student prepare for life after school. Other activities were designed solely for the purpose of having fun.

Many times the activity that was chosen was decided upon by whether or not it answered yes to one question - "Will it get me out of class?"



Senior Ty Czesohin shows "blind faith" in his teacher and classmates during this taste test in Psychology.

Flapping his wings Mike Garrett shows his spirit riding the senior class float during homecoming.



Showing off their "Class of '92" shirts are sophomores Jelene VanHooser, Erica Gae, Kelly Schubert, and Dawn Boad.



Singing their hearts out on Valentine's Day are junior Brian Rogers, senior Amanda Hedden, junior Sean Atwell, seniors Deanna Rogers, and Chris Parr.

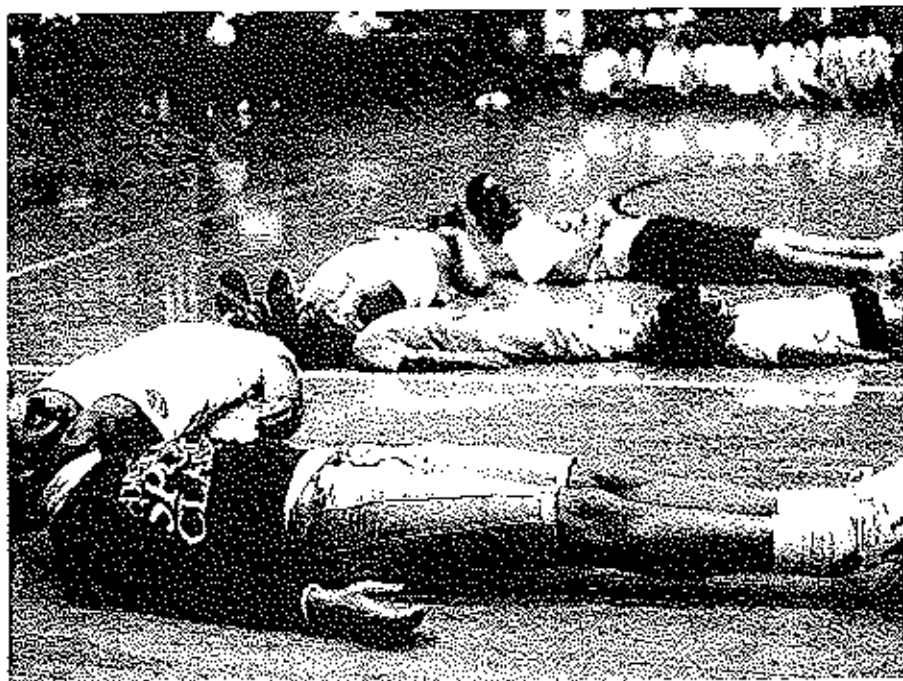

All decked out for Wild, Wild West Day are sophomores Connie McDevitt, Christie Martin, freshman John Lambeth, sophomore Chris Roberts, and junior Tony Anodell.

Members of the varsity basketball team show their school spirit by painting their faces and spelling out EHS during a pep assembly.



s of '92' lene Van-Schubert.

Where do we



go from here?

As the school year draws to a close, the one question every student must ask is, "Where do I go from here?"

Underclassmen have choices like a summer job, family vacations, or some sort of camp. Still, when the three months of vacation are over, they have to return to high school.

Graduating seniors must make much more important decisions because they are ready to begin their life away from high school. The majority of the senior class plans to attend a college in Missouri. This additional schooling provides valuable knowledge for future use in a career.

Another decision is to join the military. After serving for the required amount of time, the person may make that their career or decide to go back to school. Others may go straight to work after graduation. This way they can start earning money and begin their way up the job ladder. Some also choose to get married and start a family right away.

Unfortunately this is a never-ending question. After a few years at whatever is chosen, we all will want to know, once again, "Where do we go from here?"



The younger Publications members send the seniors off with a farewell breakfast.



Senior Mike Morgan rushes senior Stacey Fair to her class before the bell rings.

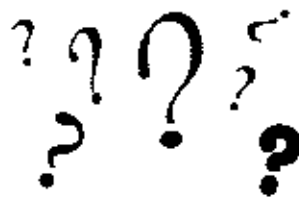

The last day of school wouldn't be complete without the famous water fight.

